

Service Manual

Cassette Deck

RS-M260

(Silver Face)
(Black Face)

3-Head Stereo Cassette Deck
with Peak-Hold 2-Color FL Meters
and Soft-Touch Controls



This is the Service Manual for the following areas.

- ☐ For all European areas except United Kingdom.
- ☒ For United Kingdom.

RS-M24 MECHANISM SERIES

Specifications

Track system:	4-track 2-channel stereo recording and playback	Outputs:	LINE; output level 700 mV, output impedance 3.5 k Ω or less, load impedance 22 k Ω over HEADPHONE; output level 125 mV, load impedance 8/125 Ω
Tape speed:	4.8 cm/s	Rec/pb connection:	5 P DIN type; input sensitivity 10 mV, input impedance 2.8 k Ω output level 700 mV, output impedance 3.5 k Ω
Wow and flutter:	0.05% (WRMS), $\pm 0.14%$ (DIN)	Bias frequency:	75 kHz
Frequency response: Metal tape;	20–20,000 Hz 25–20,000 Hz (DIN) 25–19,000 Hz ± 3 dB 30–14,000 Hz ± 3 dB (0 VU)	Motor:	Electrical control DC governor motor
CrO ₂ /Fe-Cr tape;	20–20,000 Hz 25–20,000 Hz (DIN) 25–18,000 Hz ± 3 dB	Heads:	3-head system; 2-SX (Sendust Extra) heads for record/playback (combination type) 1-sendust/ferrite double-gap head for erasure
Normal tape;	20–18,000 Hz 25–18,000 Hz (DIN) 25–16,000 Hz ± 3 dB	Power requirement:	AC; 110/125/220/240 V, 50-60 Hz
Signal-to-noise ratio: Dolby* NR in; 67 dB (above 5 kHz) Dolby NR out; 57 dB (signal level = max. recording level, Fe-Cr/CrO ₂ type tape)		Power consumption:	16 W
Fast forward and rewind time: Approx. 90 seconds with C-60 cassette tape		Dimensions:	43.0 cm(W) \times 11.9 cm(H) \times 28.2 cm(D)
Inputs: MIC; sensitivity 0.25 mV, input impedance 10 k Ω applicable microphone impedance 400 Ω –10 k Ω LINE; sensitivity 60 mV, input impedance 42 k Ω		Weight:	5.3 kg

Specifications are subject to change without notice.

* 'Dolby' and the double-D symbol are trademarks of Dolby Laboratories.

Technics

Matsushita Electric Trading Co., Ltd.

P.O. Box 288, Central Osaka Japan

CONTENTS

ITEM	PAGE
LOCATION OF CONTROLS AND COMPONENTS	1
DISASSEMBLY INSTRUCTIONS	2
MEASUREMENT AND ADJUSTMENT METHODS	3
ELECTRICAL PARTS LOCATION	10
SCHEMATIC DIAGRAM	11
CIRCUIT BOARDS	12
WIRING CONNECTION DIAGRAM	13
MECHANICAL PARTS LOCATION	13
CABINET PARTS LOCATION	15

LOCATION OF CONTROLS AND COMPONENTS

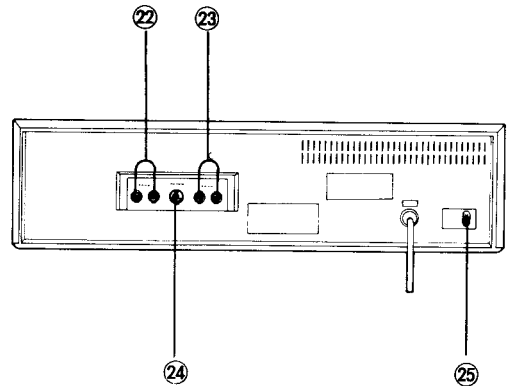
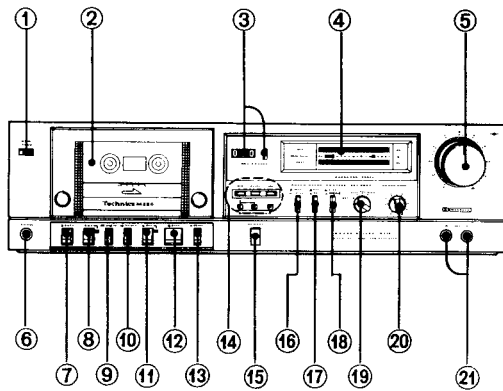

- | | |
|--|--|
| <ul style="list-style-type: none"> ① Power switch (power) ② Cassette holder ③ Tape counter and Reset button (tape counter) ④ FL (fluorescent level) meters ⑤ Input level controls (input level) (L → R) ⑥ Headphones jack (phones) ⑦ Eject button (▲ eject) ⑧ Record button (○ rec) ⑨ Rewind/Review button (◀◀ rew/rev) ⑩ Fast forward/Cue button (▶▶ ff/cue) ⑪ Play button (▶ play) ⑫ Stop button (■ stop) ⑬ Pause button (pause) | <ul style="list-style-type: none"> ⑭ 3 head LED display (3 Head System) ⑮ Record-muting button (rec mute) ⑯ Monitor switch (monitor) ⑰ Dolby noise-reduction switch (Dolby NR) ⑱ Input selector (input select) ⑲ Tape selector (tape select) ⑳ Output level control (output level) ㉑ Microphone jacks (L mic R) ㉒ Line output jacks (LINE OUT) (R · L) ㉓ Line input jacks (LINE IN) (R · L) ㉔ Record/Playback connection socket (REC/PB) ㉕ Voltage selector (VOLTAGE SELECTOR) |
|--|--|

DISASSEMBLY INSTRUCTIONS

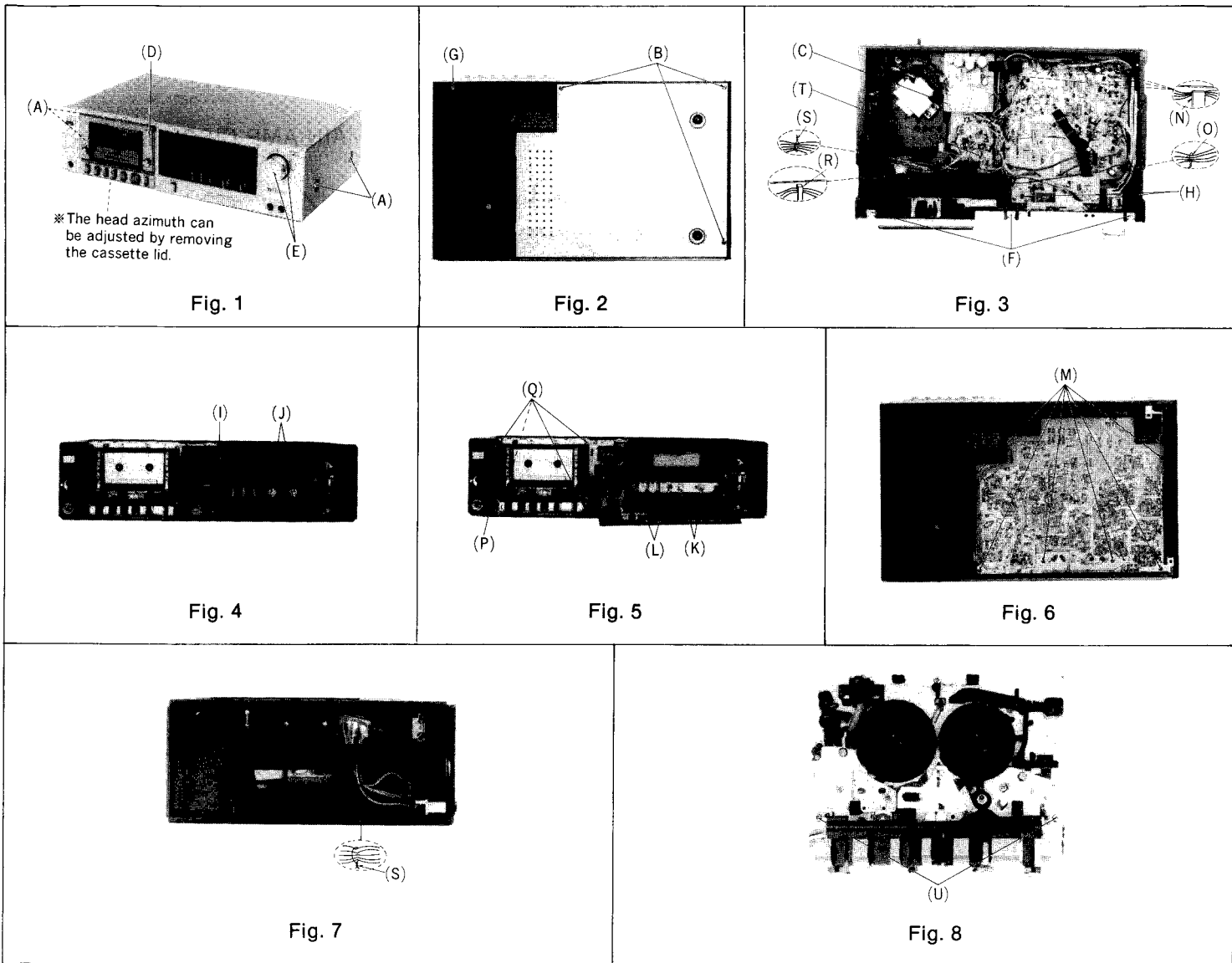

Ref. No.	Procedure	To remove _____	Remove _____	Shown in fig. _____
1	1	Case cover	• 4 screws (A)	1
2	2	Bottom cover	• 3 screws (B)	2
3	1 → 3	Power supply circuit board	• 1 screw (C)	3
4	1 → 2 → 4	Front panel	• Cassette lid (D) • 2 volume knobs (E) • 3 red screws (F) • 1 screw (G)	1 1 3 2
5	1 → 2 → 4 → 5	FL meter and FL meter circuit board	• 2 screws (H)	3
6	1 → 2 → 4 → 6	Main circuit board	• Meter cover (I) • 2 knobs (J) • 2 nuts (K) • 2 screws (L) • 6 screws (M) • 3 cord clammer (N) • 1 binder (O)	4 4 5 5 6 3 3
7	1 → 2 → 4 → 7	Mechanism unit	• Cassette holder (P) • 4 red screws (Q) • 1 cord clammer (R) • 2 binders (S) • 3 pin-socket [E] (T)	5 5 3 3, 7 3
8	1 → 2 → 4 → 7 → 8	Operation button assembly	• 2 screws (U)	8

MEASUREMENT AND ADJUSTMENT METHODS

CIRCUIT BOARD AND ADJUSTMENT PARTS LOCATION

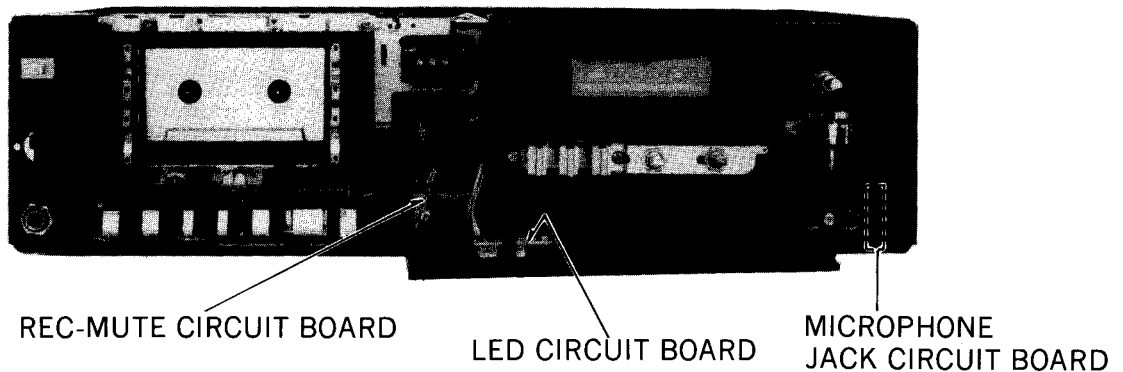
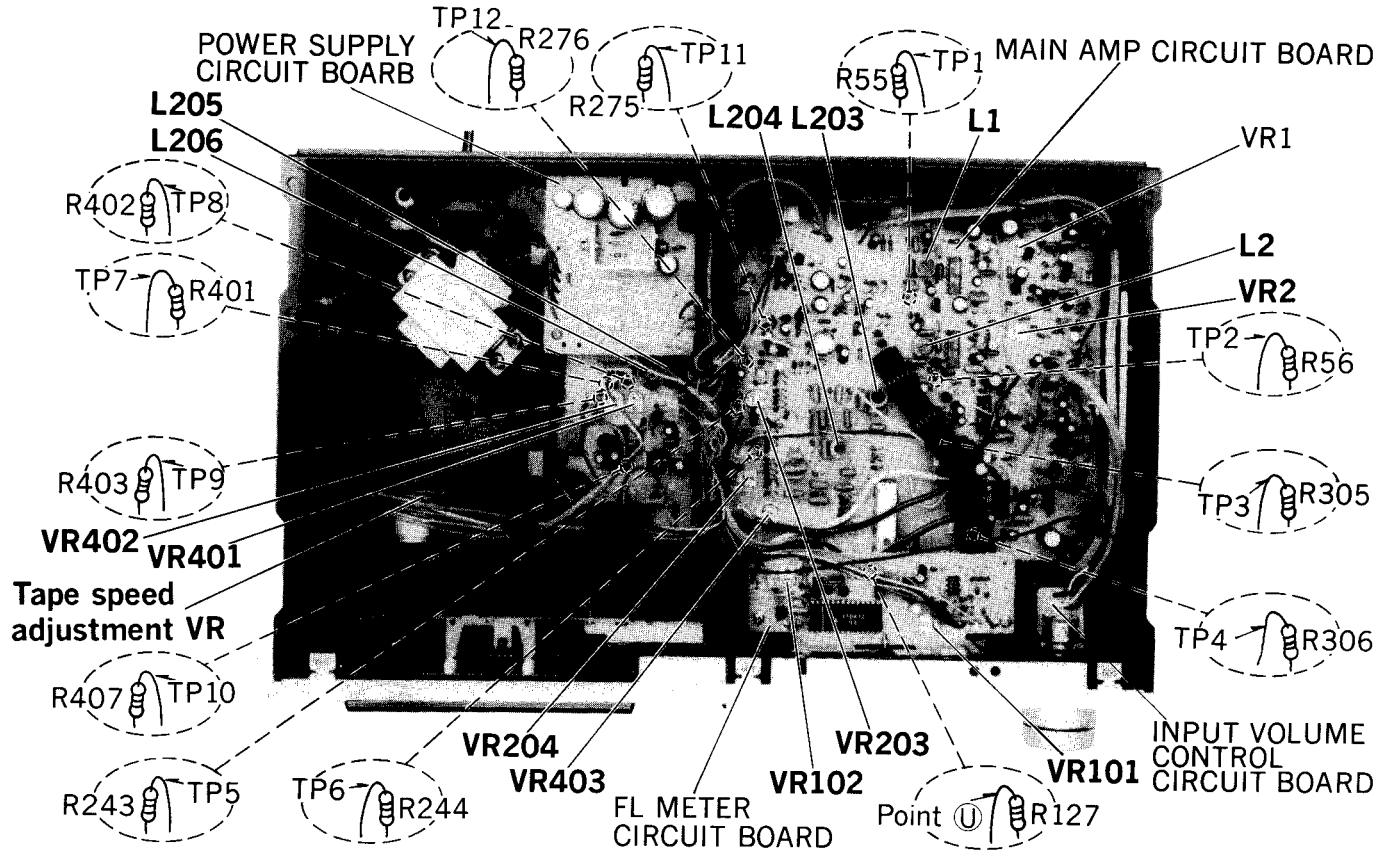
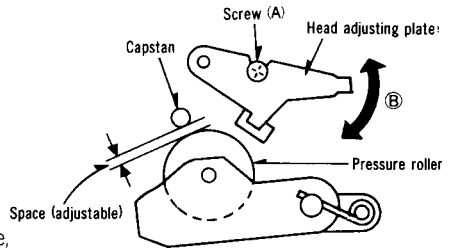
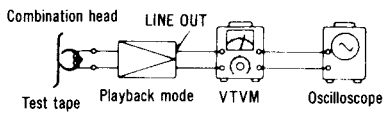
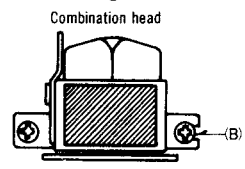
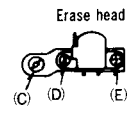
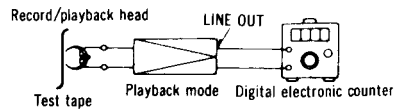

Fig. 1

NOTES: Set switches and controls in the following positions, unless specified otherwise.

- Make sure heads are clean.
- Make sure capstan and pressure roller are clean.
- Judgeable room temperature: $20 \pm 5^\circ\text{C}$ ($68 \pm 9^\circ\text{F}$).
- Tape selector: Normal.
- Monitor selector: Tape.
- Input level controls: Maximum.
- Output level control: Maximum.
- Dolby NR selector: Out.
- Input selector: Line.

ITEM	MEASUREMENT & ADJUSTMENT
<p>A Head position adjustment</p> <p>Condition:</p> <ul style="list-style-type: none"> * Playback and pause mode 	<p>(The head adjusting plate is provided to adjust the tape touch of the head in cue or review mode.)</p> <ol style="list-style-type: none"> 1. Press the playback button and pause button. 2. Measure the space between the pinch roller and the capstan. <div style="border: 1px solid black; padding: 5px; width: fit-content; margin: 10px auto;"> <p>Standard value: $0.5 \pm 0.3\text{mm}$</p> </div> <ol style="list-style-type: none"> 3. If the measured value is not within the standard value, untighten screw (A), and slide the head adjusting plate in the direction of arrow (B) for adjustment (Fig. 2).  <p style="text-align: center;">Fig. 2</p>
<p>B Head azimuth adjustment</p> <p>Condition:</p> <ul style="list-style-type: none"> * Playback mode <p>Equipment:</p> <ul style="list-style-type: none"> * VTVM * Oscilloscope * Test tape (azimuth) ...QZZCFM * Test tape (tape path viewer) ...QZZCRD 	<p>Combination head azimuth adjustment</p> <ol style="list-style-type: none"> 1. Test equipment connection is shown in fig. 3. 2. Playback azimuth tape (QZZCFM 8kHz). 3. Adjust record/playback head angle adjustment screw (B) in fig. 4 so that output level at LINE OUT becomes maximum. 4. Measure both channels, and adjust levels for equal output. 5. After adjustment lock head adjustment screw with lacquer.  <p style="text-align: center;">Fig. 3</p>  <p style="text-align: center;">Fig. 4</p>
<p>C Erase head height adjustment</p> <p>Condition:</p> <ul style="list-style-type: none"> * Playback mode <p>Equipment:</p> <ul style="list-style-type: none"> * Test tape (tape path viewer) ...QZZCRD 	<p>Caution:</p> <ol style="list-style-type: none"> 1. Remove screws (D) and (E) to replace the erase head. (Do not remove nut (C) since it is designed for erase head height. Adjustment to maintain performance.) 2. After erase head replacement, check by playing test tape (QZZCRD) back to see that the tape travels properly. 3. For any tape travel performance problem, follow the procedure below for adjustment. <p>Adjustment</p> <ol style="list-style-type: none"> 1. Adjust nut (C) shown in fig. 5 so that the tape may not get curled or malformed by tape guide of the erase head. 2. After adjustment, lock nut (C) with lacquer.  <p style="text-align: center;">Fig. 5</p>
<p>D Tape speed</p> <p>Condition:</p> <ul style="list-style-type: none"> * Playback mode <p>Equipment:</p> <ul style="list-style-type: none"> * Digital electronic counter or frequency counter * Test tape ...QZZCWAT 	<p>Tape speed accuracy</p> <ol style="list-style-type: none"> 1. Test equipment connection is shown in fig. 6. 2. Playback test tape (QZZCWAT 3,000Hz), and supply playback signal to frequency counter. 3. Measure this frequency. 4. On the basis of 3,000Hz, determine value by following formula: $\text{Tape speed accuracy} = \frac{f - 3,000}{3,000} \times 100 (\%) \quad \text{where, } f = \text{measured value}$ <ol style="list-style-type: none"> 5. Take measurement at middle section of tape. <div style="border: 1px solid black; padding: 5px; width: fit-content; margin: 10px auto;"> <p>Standard value: $\pm 1.5\%$</p> </div> <p>Adjustment method</p> <ol style="list-style-type: none"> 1. Playback the test tape (middle). 2. Adjust so that frequency becomes 3,000Hz. 3. Tape speed adjustment VR shown in fig. 1. <p>Note: Please use non metal type screwdriver when you adjust tape speed accuracy on this unit.</p>  <p style="text-align: center;">Fig. 6</p>

ITEM	MEASUREMENT & ADJUSTMENT																																								
	<p>Tape speed fluctuation</p> <p>Make measurements in same manner as above (beginning, middle and end of tape), and determine the difference between maximum and minimum values and calculate as follows:</p> $\text{Tape speed fluctuation} = \frac{f_1 - f_2}{3,000} \times 100 (\%) \quad f_1 = \text{maximum value}, f_2 = \text{minimum value}$ <div style="border: 1px solid black; padding: 5px; width: fit-content; margin: 10px auto;"> <p>Standard value: Less than 1%</p> </div>																																								
<p>● Playback frequency response</p> <p>Condition:</p> <ul style="list-style-type: none"> * Playback mode * Normal position * Output level control...MAX <p>Equipment:</p> <ul style="list-style-type: none"> * VTVM * Oscilloscope * Test tape... QZZCFM 	<p>Measurement</p> <ol style="list-style-type: none"> 1. Test equipment connection is shown in fig. 3. 2. Place UNIT into playback mode. 3. Playback the frequency response test tape (QZZCFM). 4. Measure output level at 315 Hz, 12.5 kHz, 8 kHz, 4 kHz, 1 kHz, 250 Hz, 125 Hz and 63 Hz and compare each output level with the standard frequency 315 Hz, at LINE OUT. 5. Make measurement for both channels. 6. Make sure that the measured value is within the range specified in the frequency response chart (Fig. 7). <div style="text-align: center;"> <p>Playback frequency response chart</p> </div> <p style="text-align: center;">Fig. 7</p> <p>Adjustment method</p> <ol style="list-style-type: none"> 1. If the measured value is not within the standard at the high frequency range, P.C.B. connection points (a) (L-CH) and (a') (R-CH) should be short-circuited (Fig. 12). In this case, connection points (b) (L-CH) and (b') (R-CH) should be opened. 2. Make measurement again according to steps from (2) to (6) of the "Measurement" above. 3. If the measured value decreases at high frequency range, as shown in fig. 8, P.C.B. connection points (b) (L-CH) and (b') (R-CH) should be shorted (Fig. 12). <div style="display: flex; justify-content: space-between; align-items: flex-start;"> <table border="1" data-bbox="566 1160 1067 1312" style="margin-right: 20px;"> <caption>Compensation value</caption> <thead> <tr> <th>4 kHz</th> <th>6 kHz</th> <th>8 kHz</th> <th>10 kHz</th> <th>12.5 kHz</th> </tr> </thead> <tbody> <tr> <td>around +0.3 dB</td> <td>around +0.5 dB</td> <td>around +0.7 dB</td> <td>around +0.7 dB</td> <td>around +0.6 dB</td> </tr> </tbody> </table> <div data-bbox="1110 1167 1417 1263" style="text-align: center;"> </div> </div> <p style="text-align: center;">Fig. 8</p> <ol style="list-style-type: none"> 4. If the measured value increases at the high frequency range, as shown in fig. 9, P.C.B. connection points (a) (L-CH) and (a') (R-CH) should be opened. Connection points (b) (L-CH) and (b') (R-CH) should be short-circuited. <div style="display: flex; justify-content: space-between; align-items: flex-start;"> <table border="1" data-bbox="566 1413 1067 1568" style="margin-right: 20px;"> <caption>Compensation value</caption> <thead> <tr> <th>4 kHz</th> <th>6 kHz</th> <th>8 kHz</th> <th>10 kHz</th> <th>12.5 kHz</th> </tr> </thead> <tbody> <tr> <td>around -0 dB</td> <td>around -0.3 dB</td> <td>around -0.4 dB</td> <td>around -0.5 dB</td> <td>around -0.7 dB</td> </tr> </tbody> </table> <div data-bbox="1110 1429 1417 1525" style="text-align: center;"> </div> </div> <p style="text-align: center;">Fig. 9</p> <ol style="list-style-type: none"> 5. If the measured value decreases at middle frequency range, as shown in fig. 10, P.C.B. connection points (c) (L-CH) and (c') (R-CH) should be opened (Fig. 12). <div style="display: flex; justify-content: space-between; align-items: flex-start;"> <table border="1" data-bbox="566 1648 1067 1803" style="margin-right: 20px;"> <caption>Compensation value</caption> <thead> <tr> <th>700 Hz</th> <th>1 kHz</th> <th>2 kHz</th> <th>4 kHz</th> <th>10 kHz</th> </tr> </thead> <tbody> <tr> <td>around +0.2 dB</td> <td>around +0.4 dB</td> <td>around +0.7 dB</td> <td>around +0.7 dB</td> <td>around +0.9 dB</td> </tr> </tbody> </table> <div data-bbox="1110 1664 1417 1760" style="text-align: center;"> </div> </div> <p style="text-align: center;">Fig. 10</p> <ol style="list-style-type: none"> 6. If the measured value increases at middle frequency range, as shown in fig. 11, P.C.B. connection points (c) (L-CH) and (c') (R-CH) should be shorted (Fig. 12). <div style="display: flex; justify-content: space-between; align-items: flex-start;"> <table border="1" data-bbox="566 1917 1067 2027" style="margin-right: 20px;"> <caption>Compensation value</caption> <thead> <tr> <th>700 Hz</th> <th>1 kHz</th> <th>2 kHz</th> <th>4 kHz</th> <th>10 kHz</th> </tr> </thead> <tbody> <tr> <td>around -0.2 dB</td> <td>around -0.4 dB</td> <td>around -0.7 dB</td> <td>around -0.9 dB</td> <td>around -0.9 dB</td> </tr> </tbody> </table> <div data-bbox="1110 1888 1417 1984" style="text-align: center;"> </div> </div> <p style="text-align: center;">Fig. 11</p>	4 kHz	6 kHz	8 kHz	10 kHz	12.5 kHz	around +0.3 dB	around +0.5 dB	around +0.7 dB	around +0.7 dB	around +0.6 dB	4 kHz	6 kHz	8 kHz	10 kHz	12.5 kHz	around -0 dB	around -0.3 dB	around -0.4 dB	around -0.5 dB	around -0.7 dB	700 Hz	1 kHz	2 kHz	4 kHz	10 kHz	around +0.2 dB	around +0.4 dB	around +0.7 dB	around +0.7 dB	around +0.9 dB	700 Hz	1 kHz	2 kHz	4 kHz	10 kHz	around -0.2 dB	around -0.4 dB	around -0.7 dB	around -0.9 dB	around -0.9 dB
4 kHz	6 kHz	8 kHz	10 kHz	12.5 kHz																																					
around +0.3 dB	around +0.5 dB	around +0.7 dB	around +0.7 dB	around +0.6 dB																																					
4 kHz	6 kHz	8 kHz	10 kHz	12.5 kHz																																					
around -0 dB	around -0.3 dB	around -0.4 dB	around -0.5 dB	around -0.7 dB																																					
700 Hz	1 kHz	2 kHz	4 kHz	10 kHz																																					
around +0.2 dB	around +0.4 dB	around +0.7 dB	around +0.7 dB	around +0.9 dB																																					
700 Hz	1 kHz	2 kHz	4 kHz	10 kHz																																					
around -0.2 dB	around -0.4 dB	around -0.7 dB	around -0.9 dB	around -0.9 dB																																					

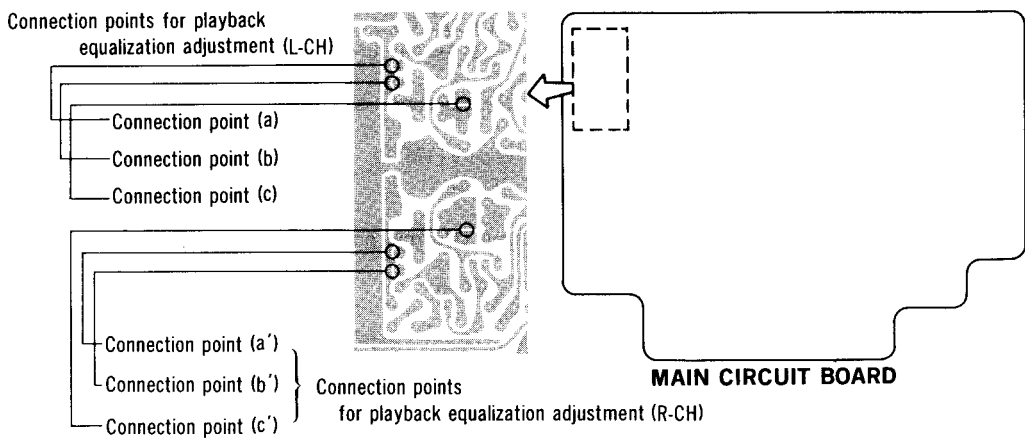
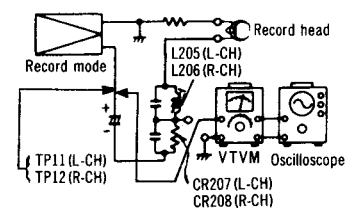
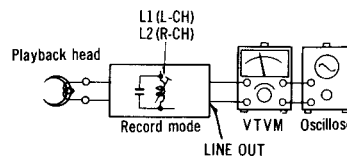
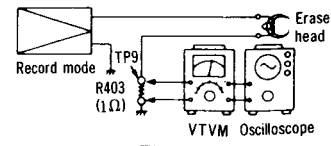
ITEM	MEASUREMENT & ADJUSTMENT
	 <p style="text-align: center;">Fig. 12</p>
<p>Ⓔ Playback gain</p> <p>Condition:</p> <ul style="list-style-type: none"> * Playback mode * Normal position * Output level control ... MAX <p>Equipment:</p> <ul style="list-style-type: none"> * VTVM * Oscilloscope * Test tape ... QZZCFM 	<ol style="list-style-type: none"> 1. Test equipment connection is shown in fig. 3. 2. Playback standard recording level portion on test tape (QZZCFM 315Hz), and using VTVM measure the output level at LINE OUT. 3. Make measurement for both channels. <div style="border: 1px solid black; padding: 5px; width: fit-content; margin: 10px auto;"> <p style="text-align: center;">Standard value: around 0.7 V</p> </div> <p>Adjustment</p> <ol style="list-style-type: none"> 1. If measured value is not standard, adjust VR1 (L-CH), VR2 (R-CH) (See fig. 1). 2. After adjustment, check "Ⓔ Playback frequency response" again.
<p>Ⓒ Bias leakage</p> <p>Condition:</p> <ul style="list-style-type: none"> * Record mode * Input level controls ... MAX * Output level control ... MAX * Tape selector ... Metal position <p>Equipment:</p> <ul style="list-style-type: none"> * VTVM * Oscilloscope 	<p>Adjustment (For record amp)</p> <ol style="list-style-type: none"> 1. Test equipment connection is shown in fig. 13. 2. Place UNIT into record mode. 3. Adjust trap coils L205 (L-CH), L206 (R-CH), so that measured value becomes minimum. <p>Adjustment (For playback amp)</p> <ol style="list-style-type: none"> 1. Test equipment connection is shown in fig. 14. 2. Turn the UNIT into record mode and set the monitor selector to tape position. 3. Adjust trap coils L1 (L-CH) and L2 (R-CH), so that measured values are minimized at LINE OUT. <div style="text-align: right;">  <p style="text-align: center;">Fig. 13</p>  <p style="text-align: center;">Fig. 14</p> </div>
<p>Ⓕ Erase current</p> <p>Condition:</p> <ul style="list-style-type: none"> * Record mode * Tape selector ... Metal position <p>Equipment:</p> <ul style="list-style-type: none"> * VTVM * Oscilloscope 	<ol style="list-style-type: none"> 1. Test equipment connection is shown in fig. 15. 2. Place UNIT into record mode and measure voltage at test point 9. 3. Determine erase current with the following formula: $\text{Erase current (A)} = \frac{\text{Voltage across both ends of R403}}{1 (\Omega)}$ <div style="border: 1px solid black; padding: 5px; width: fit-content; margin: 10px auto;"> <p style="text-align: center;">Standard value: 100 \pm 20 / 5 mA (Tape selector ... Metal)</p> </div> <ol style="list-style-type: none"> 4. If measured value is not within standard, adjust VR403. <div style="text-align: right;">  <p style="text-align: center;">Fig. 15</p> </div>

ITEM	MEASUREMENT & ADJUSTMENT																																																																																																								
<p>① Bias current</p> <p>Condition:</p> <ul style="list-style-type: none"> * Record mode * Tape selector <ul style="list-style-type: none"> ... Normal position ... Fe-Cr position ... CrO₂ position ... Metal position <p>Equipment:</p> <ul style="list-style-type: none"> * VTVM * Oscilloscope 	<ol style="list-style-type: none"> 1. Test equipment connection is shown in fig. 16. 2. Place UNIT into record mode, and tape selector to normal position. 3. Read voltage on VTVM and calculate bias current by following formula: $\text{Bias current (A)} = \frac{\text{Value read on VTVM (V)}}{10 (\Omega)}$ <div style="border: 1px solid black; padding: 5px; margin: 10px 0;"> <p align="center">Standard value: 0.7 ± 0.3 mA (Normal position)</p> </div> <ol style="list-style-type: none"> 4. Adjust VR402 (L-CH) and VR401 (R-CH). 5. Set the tape selector to each position. 6. Make sure that the measured value is within standard. <div style="border: 1px solid black; padding: 5px; margin: 10px 0;"> <p align="center">Standard value: 0.75 ± 0.3 mA (Fe-Cr position) 1.0 ± 0.3 mA (CrO₂ position) 1.6 ± 0.3 mA (Metal position)</p> </div>																																																																																																								
<p>② Overall gain</p> <p>Condition:</p> <ul style="list-style-type: none"> * Record/playback mode * Tape selector <ul style="list-style-type: none"> ... Normal position ... Fe-Cr position ... CrO₂ position ... Metal position * Input level controls ... MAX * Output level control ... MAX * Standard input level: <ul style="list-style-type: none"> MIC - 72 ± 3 dB LINE IN ... - 24 ± 3 dB <p>Equipment:</p> <ul style="list-style-type: none"> * VTVM * AF oscillator * ATT * Oscilloscope * Test tape (reference blank tape) <ul style="list-style-type: none"> ... QZZCRA for Normal ... QZZCRX for Fe-Cr ... QZZCRY for CrO₂ ... QZZCRZ for Metal 	<ol style="list-style-type: none"> 1. Test equipment connection is shown in fig. 17. 2. Place the test tape (QZZCRA) in the cassette holder. 3. Place UNIT into record mode, and tape selector to normal position. 4. Supply 1kHz signal (-24 dB) from AF oscillator, through ATT to LINE IN. 5. Adjust ATT until monitor level at LINE OUT becomes 0.7V. 6. Using test tape, make recording. 7. Playback recorded tape, and measure the output level at LINE OUT on VTVM. <div style="border: 1px solid black; padding: 5px; margin: 10px 0;"> <p align="center">Standard value: 0.7 V ± 1.5 dB (Normal position)</p> </div> <ol style="list-style-type: none"> 8. If measured value is not within standard, adjust VR203 (L-CH), VR204 (R-CH). 9. Repeat from step (4). 10. Change the tape selector to each position. 11. Change test tape to Fe-Cr (QZZCRY), CrO₂ (QZZCRX) and Metal (QZZCRZ). 12. Place UNIT into record mode. 13. Playback recorded tape, and measure the output level at LINE OUT on VTVM. <div style="border: 1px solid black; padding: 5px; margin: 10px 0;"> <p align="center">Standard value: 0.7 V ± 1.5 dB (Fe-Cr, CrO₂ and Metal position)</p> </div> <ol style="list-style-type: none"> 14. If measured value is not within standard, adjust as follows. 15. Adjust overall gain by short-circuiting or opening the point on the printed pattern in fig. 18, so that each positions approach their standard values. 16. Refer to the following tables for overall gain adjustment. <table border="1" style="width: 100%; border-collapse: collapse; text-align: center;"> <thead> <tr> <th colspan="3">Fe-Cr position (L-CH)</th> <th colspan="3">CrO₂ position (L-CH)</th> <th colspan="3">Metal position (L-CH)</th> </tr> <tr> <th>Gain</th> <th>Point (d)</th> <th>Point (e)</th> <th>Gain</th> <th>Point (f)</th> <th>Point (g)</th> <th>Gain</th> <th>Point (h)</th> <th>Point (i)</th> </tr> </thead> <tbody> <tr> <td>LOW</td> <td>CLOSE</td> <td>CLOSE</td> <td>LOW</td> <td>CLOSE</td> <td>CLOSE</td> <td>LOW</td> <td>CLOSE</td> <td>CLOSE</td> </tr> <tr> <td rowspan="2">↕</td> <td>CLOSE</td> <td>OPEN</td> <td rowspan="2">↕</td> <td>CLOSE</td> <td>OPEN</td> <td rowspan="2">↕</td> <td>CLOSE</td> <td>OPEN</td> </tr> <tr> <td>OPEN</td> <td>CLOSE</td> <td>OPEN</td> <td>CLOSE</td> <td>OPEN</td> <td>CLOSE</td> <td>CLOSE</td> </tr> <tr> <td>HIGH</td> <td>OPEN</td> <td>OPEN</td> <td>HIGH</td> <td>OPEN</td> <td>OPEN</td> <td>HIGH</td> <td>OPEN</td> <td>OPEN</td> </tr> </tbody> </table> <table border="1" style="width: 100%; border-collapse: collapse; text-align: center;"> <thead> <tr> <th colspan="3">Fe-Cr position (R-CH)</th> <th colspan="3">CrO₂ position (R-CH)</th> <th colspan="3">Metal position (R-CH)</th> </tr> <tr> <th>Gain</th> <th>Point (d')</th> <th>Point (e')</th> <th>Gain</th> <th>Point (f')</th> <th>Point (g')</th> <th>Gain</th> <th>Point (h')</th> <th>Point (i')</th> </tr> </thead> <tbody> <tr> <td>LOW</td> <td>CLOSE</td> <td>CLOSE</td> <td>LOW</td> <td>CLOSE</td> <td>CLOSE</td> <td>LOW</td> <td>CLOSE</td> <td>CLOSE</td> </tr> <tr> <td rowspan="2">↕</td> <td>CLOSE</td> <td>OPEN</td> <td rowspan="2">↕</td> <td>CLOSE</td> <td>OPEN</td> <td rowspan="2">↕</td> <td>CLOSE</td> <td>OPEN</td> </tr> <tr> <td>OPEN</td> <td>CLOSE</td> <td>OPEN</td> <td>CLOSE</td> <td>OPEN</td> <td>OPEN</td> <td>CLOSE</td> </tr> <tr> <td>HIGH</td> <td>OPEN</td> <td>OPEN</td> <td>HIGH</td> <td>OPEN</td> <td>OPEN</td> <td>HIGH</td> <td>OPEN</td> <td>OPEN</td> </tr> </tbody> </table>	Fe-Cr position (L-CH)			CrO ₂ position (L-CH)			Metal position (L-CH)			Gain	Point (d)	Point (e)	Gain	Point (f)	Point (g)	Gain	Point (h)	Point (i)	LOW	CLOSE	CLOSE	LOW	CLOSE	CLOSE	LOW	CLOSE	CLOSE	↕	CLOSE	OPEN	↕	CLOSE	OPEN	↕	CLOSE	OPEN	OPEN	CLOSE	OPEN	CLOSE	OPEN	CLOSE	CLOSE	HIGH	OPEN	OPEN	HIGH	OPEN	OPEN	HIGH	OPEN	OPEN	Fe-Cr position (R-CH)			CrO ₂ position (R-CH)			Metal position (R-CH)			Gain	Point (d')	Point (e')	Gain	Point (f')	Point (g')	Gain	Point (h')	Point (i')	LOW	CLOSE	CLOSE	LOW	CLOSE	CLOSE	LOW	CLOSE	CLOSE	↕	CLOSE	OPEN	↕	CLOSE	OPEN	↕	CLOSE	OPEN	OPEN	CLOSE	OPEN	CLOSE	OPEN	OPEN	CLOSE	HIGH	OPEN	OPEN	HIGH	OPEN	OPEN	HIGH	OPEN	OPEN
Fe-Cr position (L-CH)			CrO ₂ position (L-CH)			Metal position (L-CH)																																																																																																			
Gain	Point (d)	Point (e)	Gain	Point (f)	Point (g)	Gain	Point (h)	Point (i)																																																																																																	
LOW	CLOSE	CLOSE	LOW	CLOSE	CLOSE	LOW	CLOSE	CLOSE																																																																																																	
↕	CLOSE	OPEN	↕	CLOSE	OPEN	↕	CLOSE	OPEN																																																																																																	
	OPEN	CLOSE		OPEN	CLOSE		OPEN	CLOSE	CLOSE																																																																																																
HIGH	OPEN	OPEN	HIGH	OPEN	OPEN	HIGH	OPEN	OPEN																																																																																																	
Fe-Cr position (R-CH)			CrO ₂ position (R-CH)			Metal position (R-CH)																																																																																																			
Gain	Point (d')	Point (e')	Gain	Point (f')	Point (g')	Gain	Point (h')	Point (i')																																																																																																	
LOW	CLOSE	CLOSE	LOW	CLOSE	CLOSE	LOW	CLOSE	CLOSE																																																																																																	
↕	CLOSE	OPEN	↕	CLOSE	OPEN	↕	CLOSE	OPEN																																																																																																	
	OPEN	CLOSE		OPEN	CLOSE		OPEN	OPEN	CLOSE																																																																																																
HIGH	OPEN	OPEN	HIGH	OPEN	OPEN	HIGH	OPEN	OPEN																																																																																																	

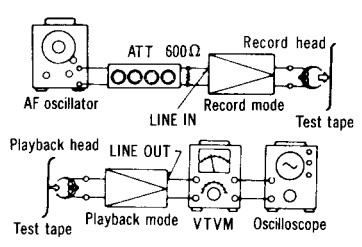
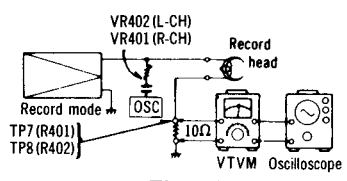

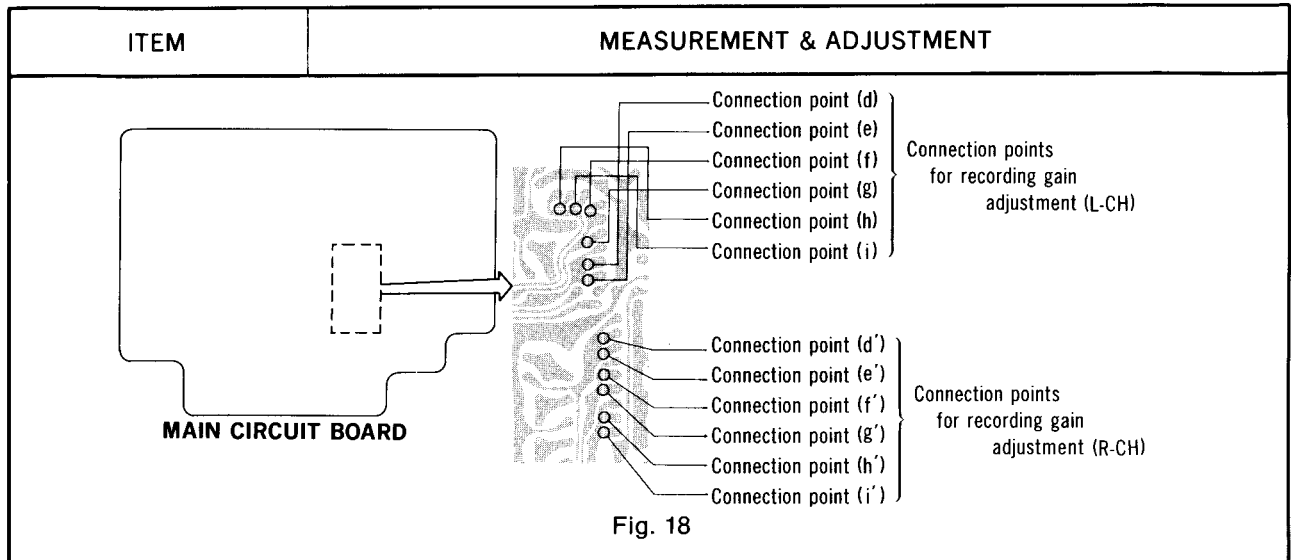

Overall frequency response

Condition:

- * Record/playback mode
- * Tape selector
 - ... Normal position
 - ... Fe-Cr position
 - ... CrO₂ position
 - ... Metal position
- * Input level controls ... MAX
- * Output level control ... MAX

Equipment:

- * VTVM * AF oscillator
- * ATT * Oscilloscope
- * Resistor (600Ω)
- * Test tape (reference blank tape)
 - ... QZZCRA for Normal
 - ... QZZCRY for Fe-Cr
 - ... QZZCRX for CrO₂
 - ... QZZCRZ for Metal

Note 1:

Before measuring and adjusting, make sure of the playback frequency response (For the method of measurement, please refer to the playback frequency response).

Note 2:

Test tape QZZCRA to be supplied after July 1980 has higher recording sensitivity in the middle and high frequency range.

* This chart indicates the standard values for the new type of QZZCRA when in use.

* This chart indicates the standard values for the former type of QZZCRA when in use.

The new type of QZZCRA is marked as shown in fig. 20.

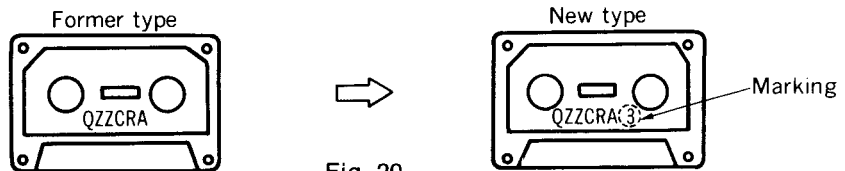

Fig. 20

Measurement

1. Test equipment connection is shown in fig. 17.
2. Place the normal test tape (QZZCRA) in the cassette holder.
3. Place UNIT into record mode, and tape selector to normal position.
4. Supply 1kHz signal from AF oscillator through ATT to LINE IN.
5. Adjust ATT so that input level is -20 dB below standard recording level (standard recording level = 0 VU).
6. At this time, LINE OUT level indicates 0.07 V.
7. Record each frequency 1kHz, 50Hz, 200Hz, 4kHz, 8kHz and 13kHz (15kHz for Fe-Cr, CrO₂ and metal).
8. Playback and express in dB the difference between playback output level of each frequency based on playback output level of 1kHz.
9. Make sure that the measured value is within the range specified in the overall frequency response chart (Shown in fig. 19).
10. Change test tape to Fe-Cr (QZZCRY), CrO₂ (QZZCRX) and metal (QZZCRZ).

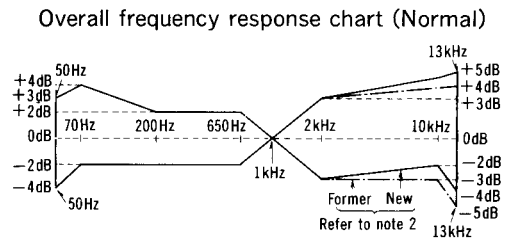

Fig. 19

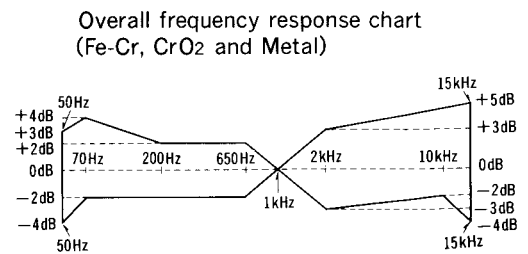
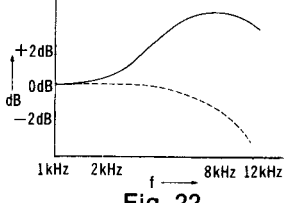
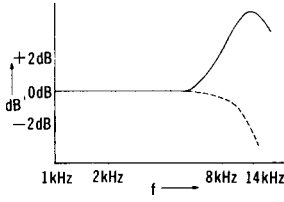
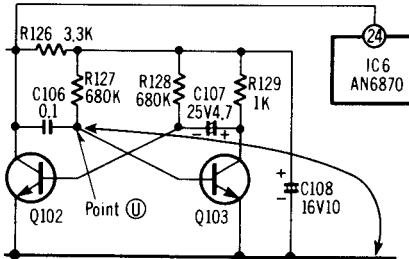
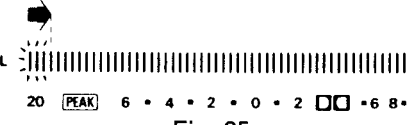
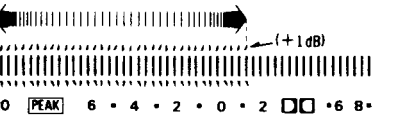

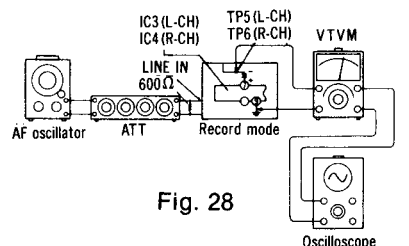
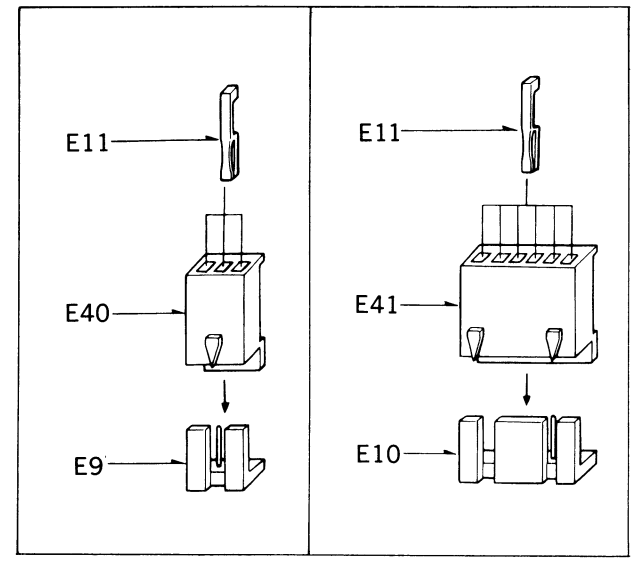
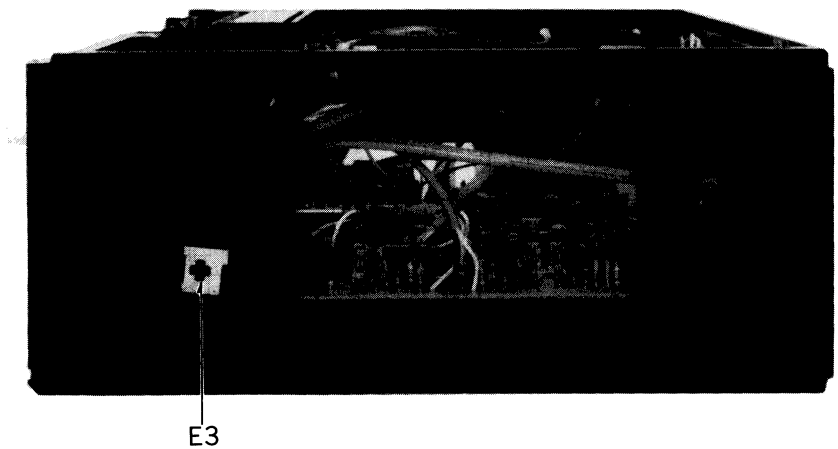
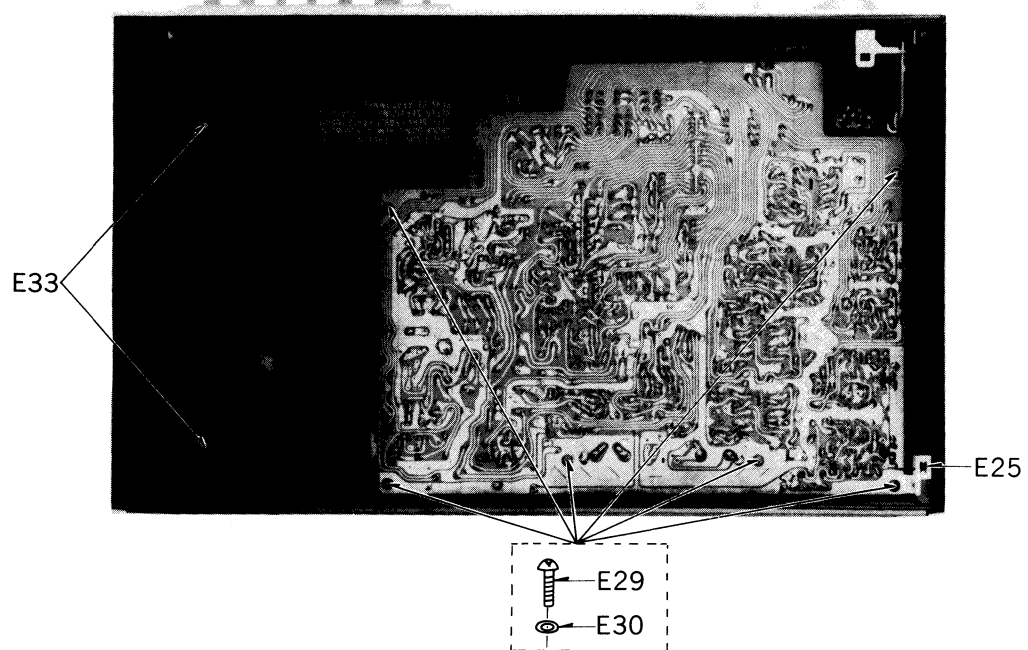
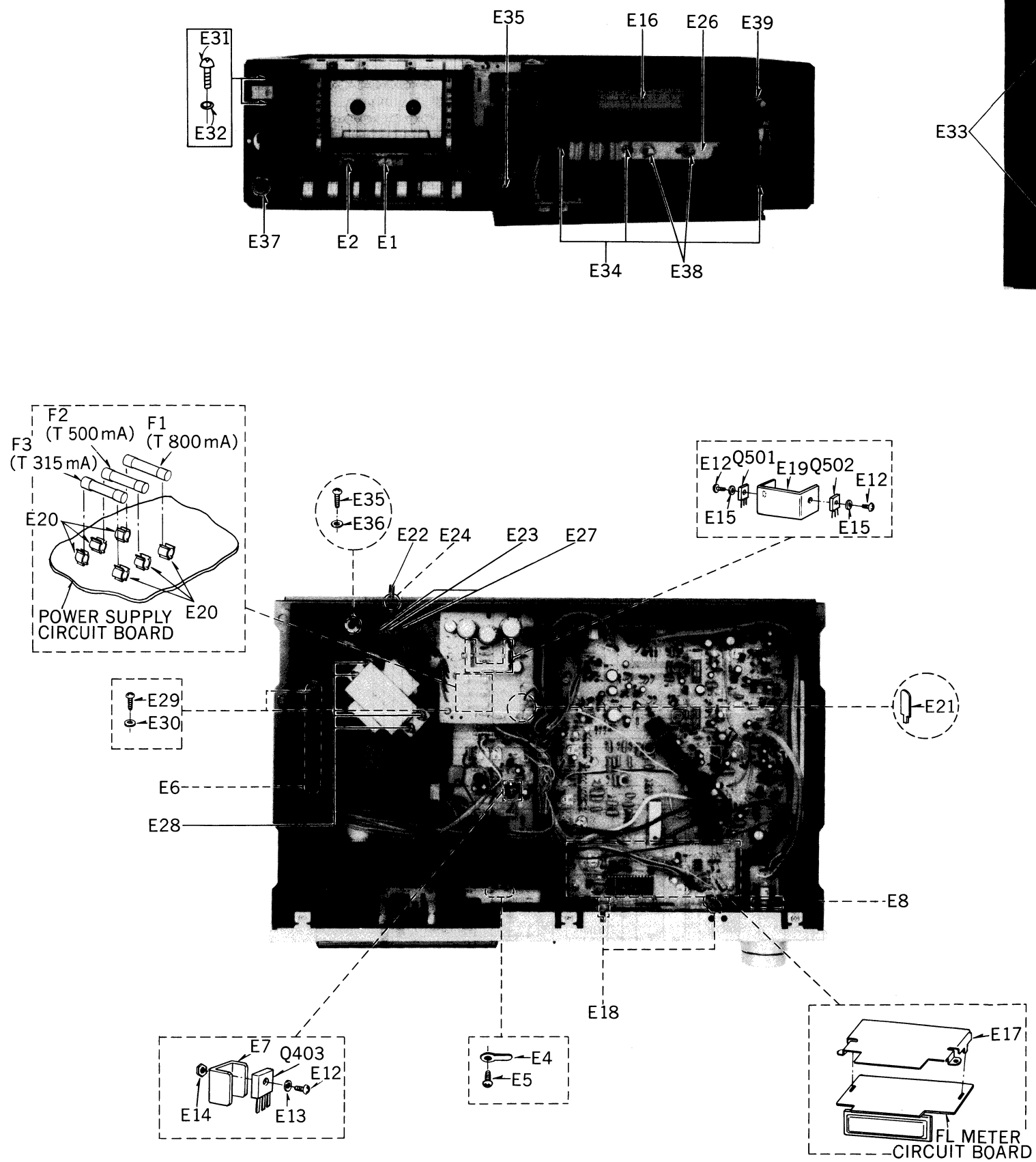

Fig. 21

ITEM	MEASUREMENT & ADJUSTMENT
	<p>11. Set the tape selector to each position. 12. Measure in the same manner from step (3) to (8). 13. Make sure that the measured value is within the range specified in the overall frequency response chart for Fe-Cr, CrO₂ and metal tape (Shown in fig. 21).</p> <p>Adjustment-1: Using bias current</p> <p>1. When the frequency response between the middle and high frequency range becomes higher than the standard value, as shown by the solid line in fig. 22, increases the bias current by turning VR402 (L-CH), VR401 (R-CH). 2. When it becomes lower, as shown by dotted line, reduce the bias current by turning VR402 (L-CH), VR401 (R-CH).</p> <p>Note: For the method of bias current measurement, refer to "Bias current adjustment" on page 7.</p> <p>Adjustment-2: Using the peaking coil for recording equalization</p> <p>When the frequency response is flat in the middle frequency range and makes a sharp rise or drop in the high frequency range, as shown in fig. 23, adjust by turning the following peaking coils. L203 (L-CH), L204 (R-CH).</p>  <p>Fig. 22</p>  <p>Fig. 23</p>
<p>● Fluorescent meter</p> <p>Condition: * Record mode * Input level controls... MAX * Output level control... MAX * Tape selector ... Normal position</p> <p>Equipment: * VTVM * AF oscillator * ATT</p>	<p>1. Test equipment connection is shown in fig. 17. 2. As shown in fig. 24, connecting the base of Q102 and ground stops the oscillation of the a stable multivibrator comprising Q102 and Q103. 3. Supply 1kHz signal (-24 dB) to the LINE IN jack, then press the record button. 4. Adjust the ATT so that the output level at LINE OUT jack becomes 0.7V (The input level at this condition is termed the standard input level). 5. Adjustment at "-20 dB": A. Adjust the ATT so that input level is -20 dB below standard recording level. B. Adjust VR101 so that the -20 dB segment lights up in the -20 ± 0.8 dB range (L-CH ONLY) (See fig. 25). 6. Adjustment at "0 dB": A. Adjust the ATT so that the output level at LINE OUT jack becomes 0.7V. (The input level at this condition is termed the standard input level.) B. Adjust VR102 so that the +1 dB segment lights up in the 0 ± 0.2 dB range of the standard input level (See fig. 26). 7. Repeat twice between steps (5) and (6) above. 8. Adjust ATT and check that all segments light up when an input signal level is increased to 10 dB higher than the standard input level (See fig. 27).</p>  <p>Fig. 24</p>  <p>Fig. 25</p>  <p>Fig. 26</p>  <p>Fig. 27</p>
<p>● Dolby NR circuit</p> <p>Condition: * Record mode * Input level controls... MAX * Output level control... MAX</p> <p>Equipment: * VTVM * AF oscillator * ATT * Oscilloscope * Resistor (600Ω)</p>	<p>1. Test equipment connection is shown in fig. 28. 2. Place UNIT into record mode, set the Dolby NR switch to OUT position and supply to LINE IN to obtain -34.5 dB at TP5 (L-CH), TP6 (R-CH) (frequency 5 kHz). 3. Confirm that the value at IN position is $8 (\pm 2.5)$ dB greater than the value at OUT position of Dolby NR switch.</p>  <p>Fig. 28</p>

ELECTRICAL PARTS LOCATION

NOTE: Δ indicates that only parts specified by the manufacturer be used for safety.



Ref. No.	Part No.	Part Name & Description
ELECTRICAL PARTS		
E1	QWY4125Z	Record/Playback Head (Combination Type)
E2	QWY2133Z	Erase Head
E3	QTSM0035	Earth Plate (A)
E4	QTD1001	Lug Terminal
E5	XTB3+10BFZ	Tapping Screw $\varnothing 3 \times 10$
E6	QJT4017	4 Pin Terminal
E7	QTHM0010	Heat Sink (A)
E8	QTSM0021	Shield Plate
E9	QJP1921TN	3 Pin Post
E10	QJP1922TN	6 Pin Post
E11	QJT1054	Contact
E12	XSN3+8S	Screw $\varnothing 3 \times 8$
E13	XWA3B	Washer 3 ϕ
E14	XNG3ES	Nut 3 ϕ
E15	XWG3	Washer 3 ϕ
E16	QSL5006RF	FL Meter
E17	QTSM0040	Shield Plate
E18	QBMM0019	Meter Cushion
E19	QTHM0009	Heat Sink (B)
E20	Δ QTF1054	Fuse Holder
E21	QJT1067	1 Pin Terminal
E22	Δ SJA88	AC Power Cord
*For all European areas except United Kingdom.		
Δ QFC1205M		
*For United Kingdom.		
E23	QTD1164	Cord Clamper
E24	QBJ1425	Cord Bushing
E25	QTSM0043	Earth Terminal (1)
E26	QTSM0042	Earth Terminal (2)
E27	XTN3+16B	Tapping Screw $\varnothing 3 \times 16$
E28	XTB4+10BFZ	Tapping Screw $\varnothing 4 \times 10$
E29	XTN3+10B	Tapping Screw $\varnothing 3 \times 10$
E30	XWG3	Washer 3 ϕ
E31	XSN3+8S	Screw $\varnothing 3 \times 8$
E32	XWA3B	Washer
E33	XTB3+10BFZ	Tapping Screw $\varnothing 3 \times 10$
E34	XSN3+6S	Screw $\varnothing 3 \times 6$
E35	XTB3+8BFZ	Tapping Screw $\varnothing 3 \times 8$
E36	XWG3	Washer
E37	QNQ1070	Nut
E38	XNS8	Nut 8 ϕ
E39	XNS9	Nut 9 ϕ
E40	QJS1921TN	3 Pin Socket
E41	QJS1922TN	6 Pin Socket

A
B
C
D
E
F
G
H
I
J
K
L
M
N
O
P
Q

SCHEMATIC DIAGRAM

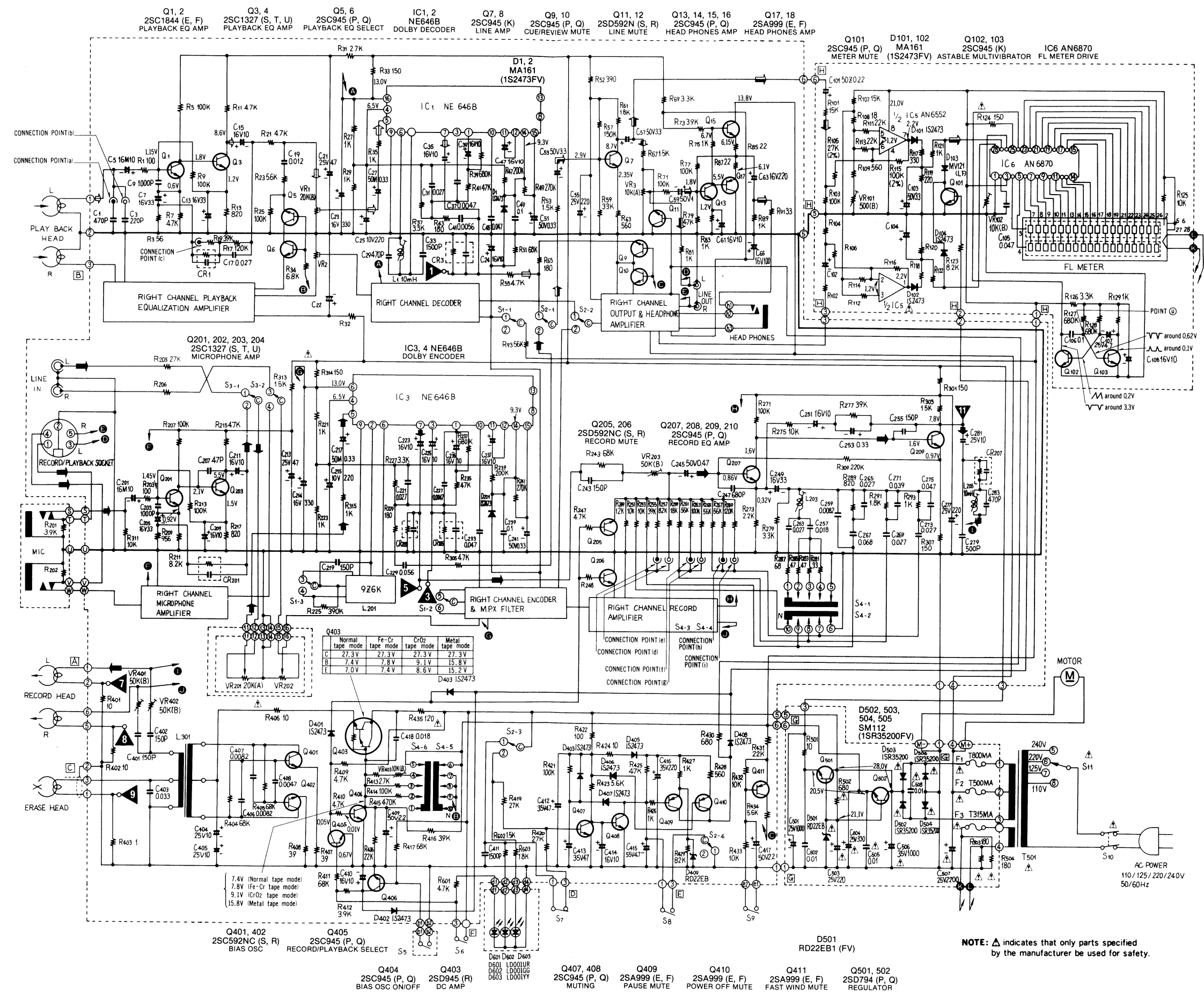

WIRING CONNECTION DIAGRAM

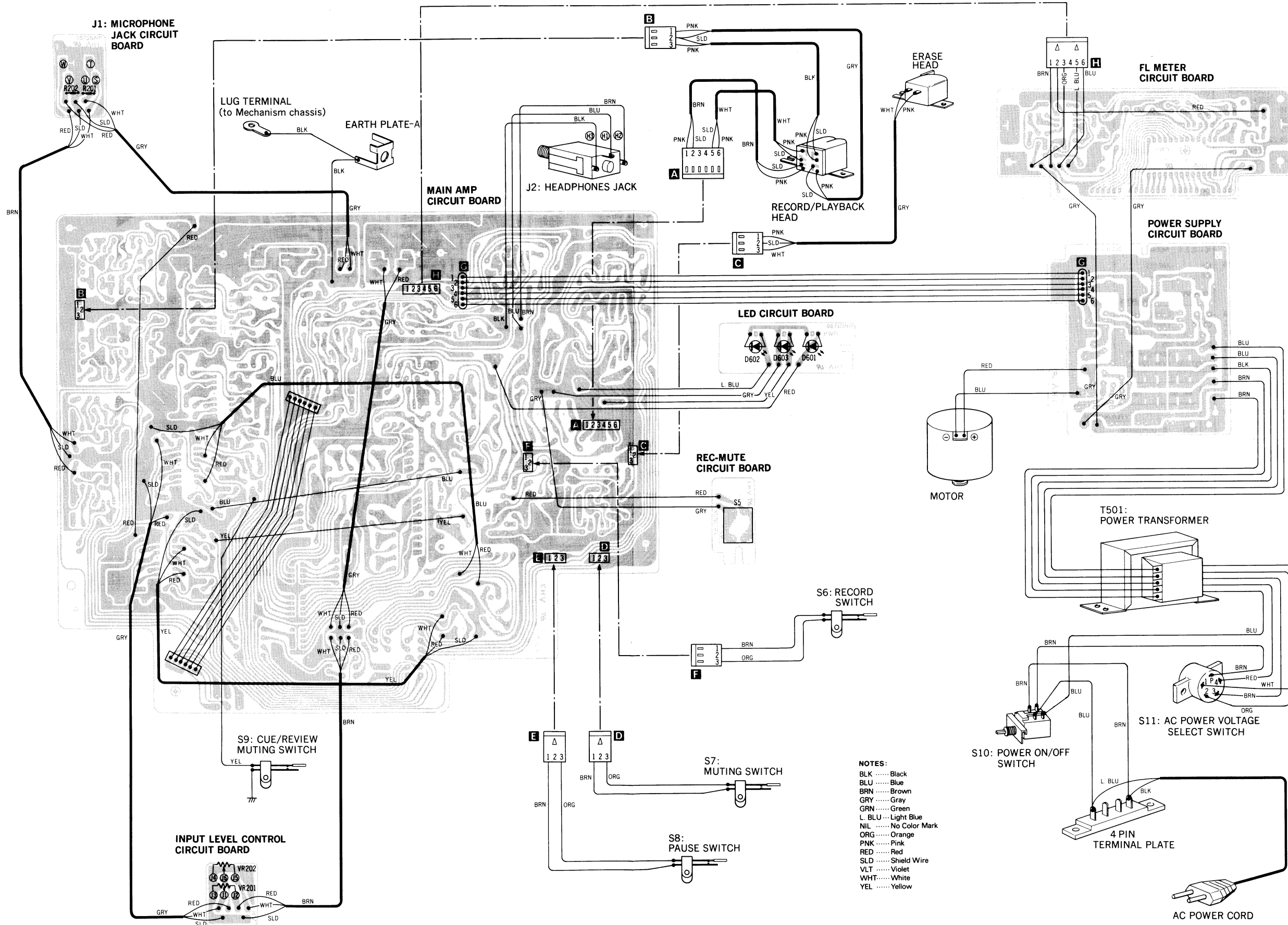

- NOTES:**
- BLK Black
 - BLU Blue
 - BRN Brown
 - GRY Gray
 - GRN Green
 - L. BLU Light Blue
 - NIL No Color Mark
 - ORG Orange
 - PNK Pink
 - RED Red
 - SLD Shield Wire
 - VLT Violet
 - WHT White
 - YEL Yellow

MECHA (FRONT VIEW)

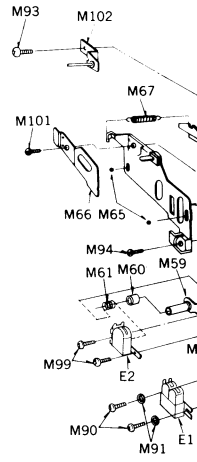

Wiring Diagram

Ref. No.	Part
M1	QBP187
M2	QDG120
M3	QDG120
M4	QMB133
M5	QDR113
M6	QMF211
M7	QML358
M8	QML358
M9	QML358
M10	QML358
M11	QML359
M12	QML360
M13	QML360
M14	QML360
M15	QML359
M16	QMR182
M17	QMR182
M18	QMR182
M19	QMR182
M20	QMI23
M21	QBC135
M22	QBT168
M23	QBT189
M24	QBN173

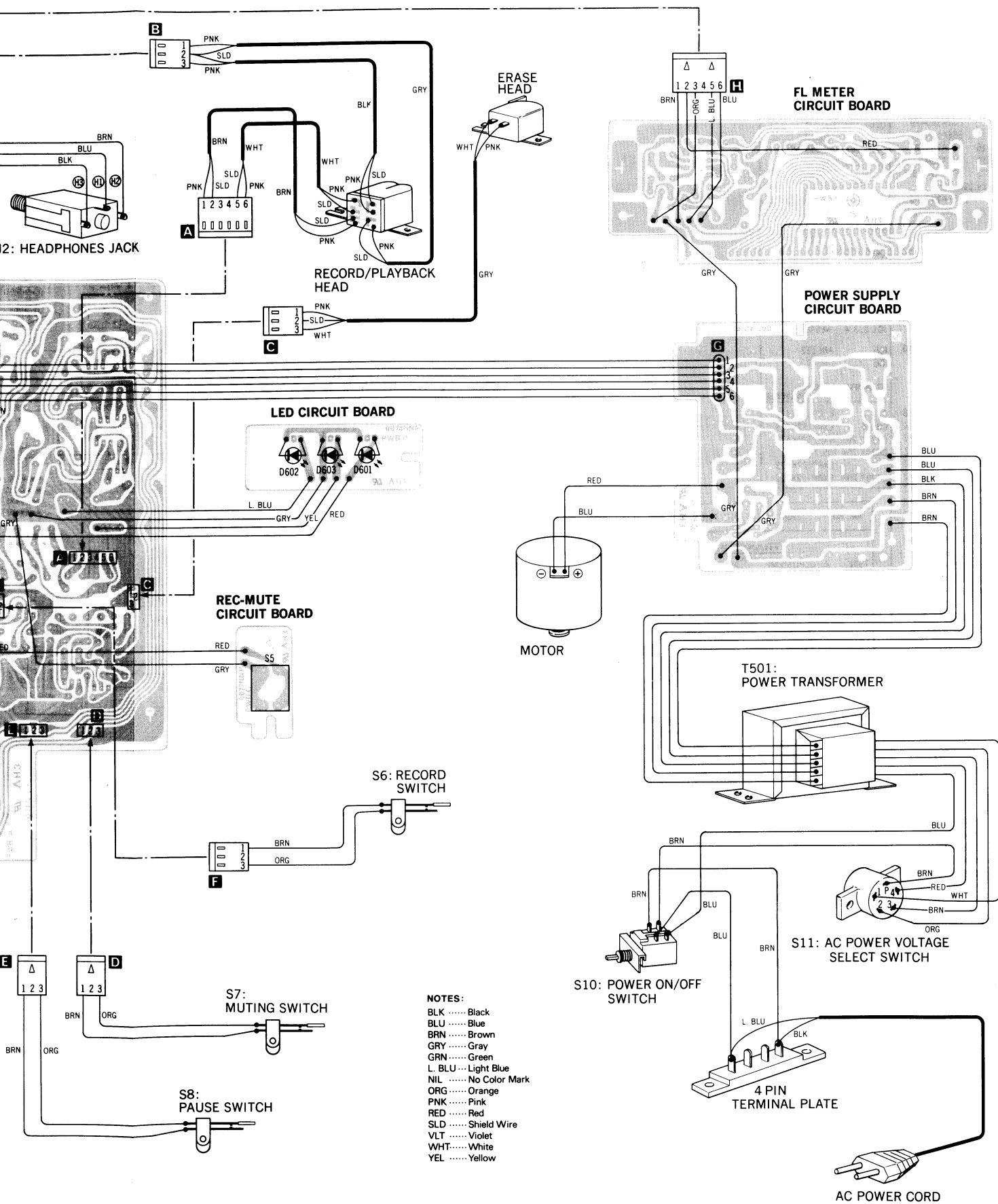

MECHANICAL PARTS LOCATION (FRONT VIEW)

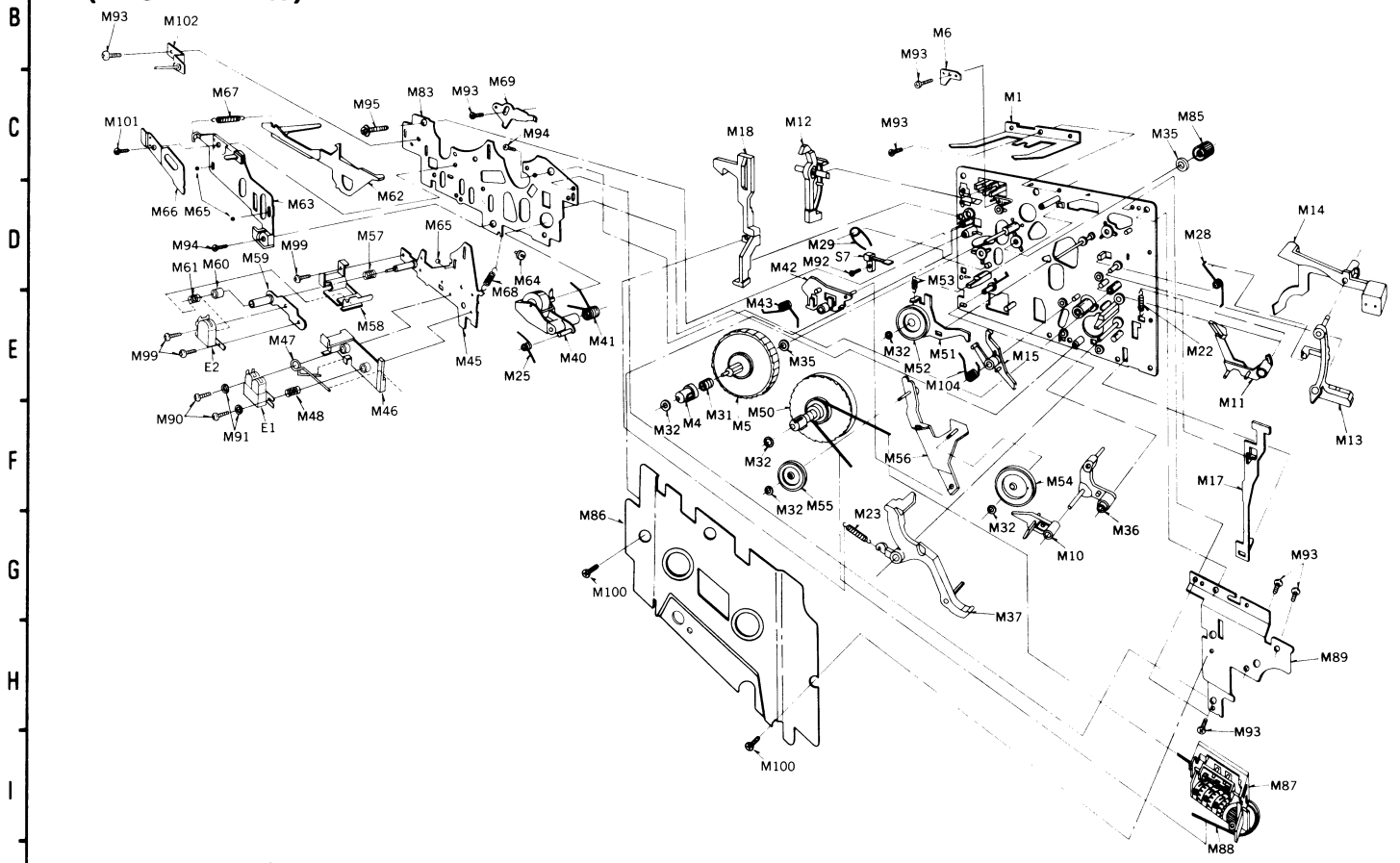

When servicing this mechanism unit, refer to the disassembly notes and assembly instructions described in the service manuals of RS-M51, RS-M13, RS-M14 and RS-M04 (RS-M24 mechanism series).

Ref. No.	Part No.	Part Name & Description	Ref. No.	Part No.	Part Name & Description	Ref. No.	Part No.	Part Name & Description
MECHANICAL PARTS								
M1	QBP1874	Cassette Pressure Spring	M25	QBN1742	Pressure Roller Release Spring	M49-1	QBW2049	Poly Washer
M2	QDG1201	Main Gear	M26	QBN1744	Sub Gear Spring	M49-2	QBW2026	Washer
M3	QDG1202	Sub Gear	M27	QBN1802	Main Gear Spring	M50	QXD1143	Takeup Reel Table Assembly
M4	QMB1336	Supply Reel Table Hub	M28	QBN1746	Auto-Stop Lever Spring	M51	QXL1382	Idler Lever Assembly
M5	QDR1139	Supply Reel Table	M29	QBN1747	Connection Spring	M52	QX10111	Takeup Idler Assembly
M6	QMF2118	Fast Forward Arm Bracket	M30	QBS1128	Lock Pin	M53	QBT1893	Takeup Idler Spring
M7	QML3581	Sub Control Lever	M31	QBC1372	Reel Table Spring	M54	QX10113	Fast Forward Idler Assembly
M8	QML3583	Main Control Lever	M32	QBW2008	Poly Washer 2φ	M55	QX10112	Rewind Idler Assembly
M9	QML3584	Record Operation Lever	M33	XUB4FT	Stop Ring 4φ	M56	QXL1383	Fast Forward Arm Assembly
M10	QML3586	Head Base Plate Lift Lever	M34	XUB3FT	Stop Ring 3φ	M57	QBC1343	Head Spring
M11	QML3594	Auto-Stop Release Arm	M35	QBW2012	Poly Washer	M58	QTD1292	Cord Clamper
M12	QML3603	Erase Safety Lever	M36	QXL1354	Sub Lever Assembly	M59	QXA1084	Erase Head Base Plate Assembly
M13	QML3604	Auto-Stop Driving Lever	M37	QXL1355	Main Lever Assembly	M60	QNQ1094	Nut (Erase Head Adjustment)
M14	QML3605	Auto-Stop Detection Lever	M38	QML3582	Pause Lock Lever	M61	QBN1788	Back Tension Spring
M15	QML3592	Change Lever	M39	QBT1896	Lever Release Spring	M62	QML3591	Brake Arm
M16	QMR1820	Record Rod	M40	QXL1381	Pressure Roller Assembly	M63	QMZ1240	Sub Head Base Plate
M17	QMR1821	Auto-Stop Connection Rod	M41	QBN1743	Pressure Roller Spring	M64	QMN2550	Roller
M18	QMR1822	Eject Rod	M42	QML3588	Fast Forward Lever	M65	QDK1017	Steel Ball 2φ
M19	QMR1824	Control Rod	M43	QBN1748	Fast Forward Spring	M66	QBP1873	Head Base Plate Pressure Spring
M20	QML2139	Flywheel Thrust Retainer	M44	QMA3861	Plunger Angle	M67	QBT1597	Brake Arm Spring
M21	QBC1357	Lock Pin Pressure Spring	M45	QXK2388	Head Base Plate Assembly	M68	QBT1892	Head Release Spring
M22	QBT1682	Auto-Stop Connection Rod Spring	M46	QMZ1258	Head Spacer	M69	QMA3858	Pressure Roller Adjustment Plate
M23	QBT1894	Main Lever Spring	M47	QBN1740	Head Pressure Spring	M70	QXG1047	Takeup Gear Assembly
M24	QBN1739	Selection Lever Spring	M48	QBCA0008	Head Spring	M71	QXU0170	Motor Assembly
			M49	QXF0164	Flywheel Assembly	M72	QXK2286	Sub Chassis Assembly

A
B
C
D
E
F
G
H
I
J
K
L
M
N
O
P
Q

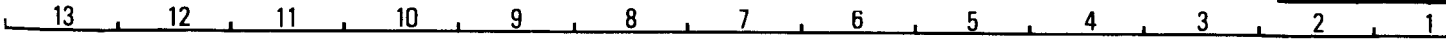

(REAR VIEW)

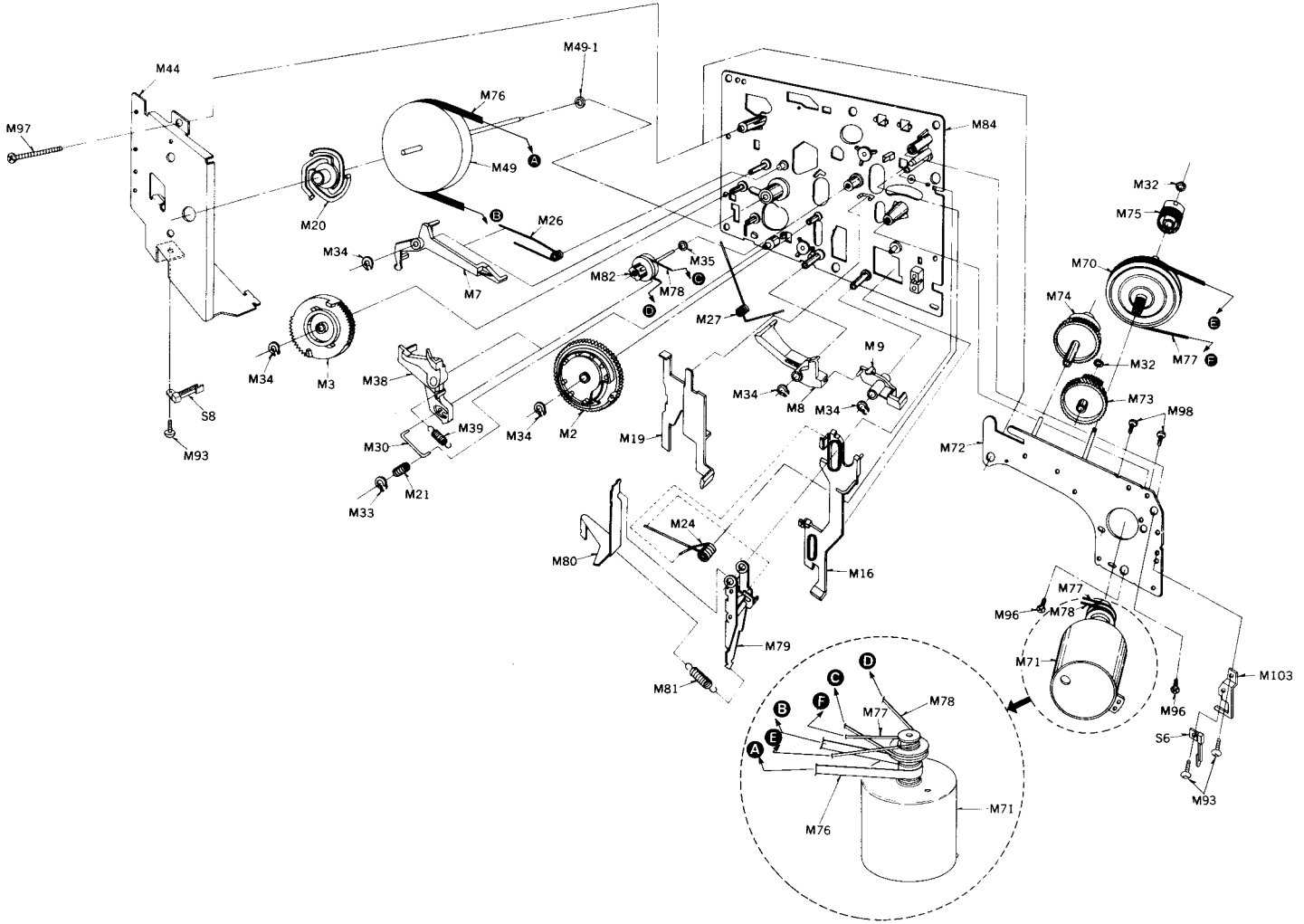

Ref. No.	Part No.	Part Name & Description	Ref. No.	Part No.	Part Name & Description
M73	QDG1199	Auto-Stop Gear	M97	XTN3+24B	Tapping Screw $\varnothing 3 \times 24$
M74	QDG1200	Cam Gear	M98	XSN26+3	Screw $\varnothing 2.6 \times 3$
M75	QDP1823	Connection Pulley	M99	XSN2+3	Screw $\varnothing 2 \times 3$
M76	QDB0281	Capstan Belt	M100	XTN26+6BFZ	Tapping Screw $\varnothing 2.6 \times 6$
M77	QDB0274	Takeup Belt	M101	XTS26+6B	Tapping Screw $\varnothing 2.6 \times 6$
M78	QDB0273	Fast Forward Belt	M102	QXA1086	Sub Angle Assembly
M79	QXL1360	Record/Playback Selection Arm Assembly	M103	QMA4011	Switch Angle
M80	QML3580	Record/Playback Selection Lever	M104	QBN1741	Change Lever Spring
M81	QBT1895	Record/Playback Selection Lever Spring			
M82	QXP0607	Fast Forward Connection Pulley Assembly			
M83	QMK1838	Upper Base Plate			
M85	QDP1828	Fast Forward Pulley			
M86	QXH0347	Chassis Cover Assembly			
M87	QXC0060	Tape Counter			
M88	QDB0240	Counter Belt			
M89	QMA3860	Counter Angle			
M90	XSN2+10	Screw $\varnothing 2 \times 10$			
M91	XWG2	Washer 2 ϕ			
M92	XTN2+6B	Tapping Screw $\varnothing 2 \times 6$			
M93	XTN26+6B	Tapping Screw $\varnothing 2.6 \times 6$			
M94	XTN26+10B	Tapping Screw $\varnothing 2.6 \times 10$			
M95	XTN26+12B	Tapping Screw $\varnothing 2.6 \times 12$			
M96	XTN3+10B	Tapping Screw $\varnothing 3 \times 10$			

SPECIFICATIONS

Pressure of pressure roller	350 \pm 50 g
Takeup tension * Use cassette torque meter ...QZZSRKCT	45 \pm 15 - 10 g-cm
Wow and flutter; (JIS) * Use test tape ...QZZCWAT	Less than 0.06% (WRMS)

CABINET PARTS LOCATION

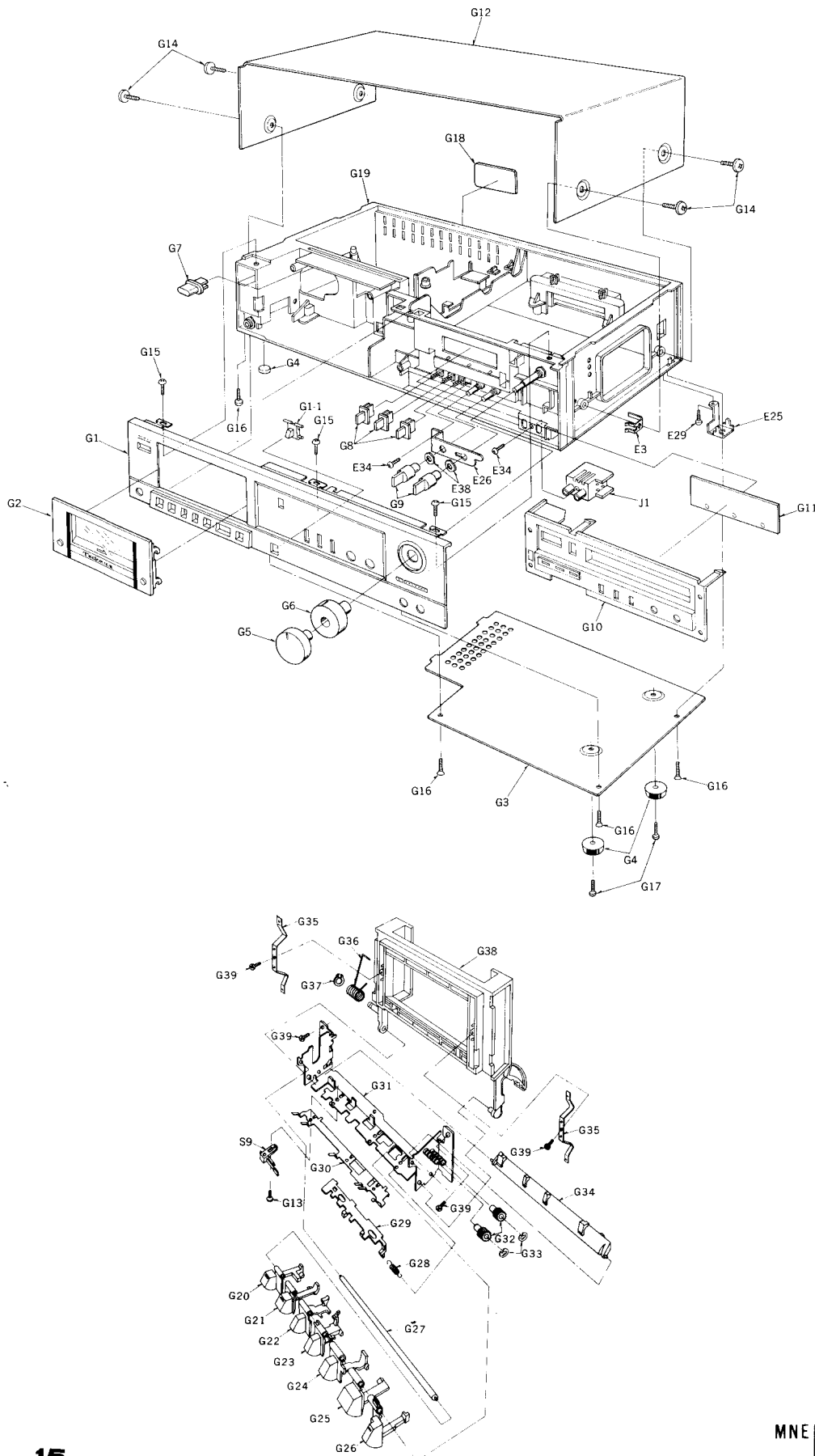

Ref. No.	Part No.	Part Name & Description
CABINET PARTS		
G1	QYPM0042 "Silver Type" QYPM0042K "Black Type"	Front Panel Assembly
G1-1	QGOM0037	Rec-Mute Button
G2	QYFM0047 "Silver Type" QYFM0047K "Black Type"	Cassette Lid Assembly
G3	QGCM0036	Bottom Cover
G4	QKA1083	Rubber Foot
G5	QYT0586 "Silver Type" QYT0586K "Black Type"	Volume Knob-A Assembly
G6	QYT0587 "Silver Type" QYT0587K "Black Type"	Volume Knob-B Assembly
G7	QGO1692N "Silver Type" QGO1692K "Black Type"	Push Button (Power ON/OFF)
G8	QGO1694N "Silver Type" QGO1694K "Black Type"	Push Button (Monitor/Dolby NR/ Input Select)
G9	QGT1515 "Silver Type" QGT1515K "Black Type"	Control Knob (Tape Select/Output Level)
G10	QYKM0008 "Silver Type" QYKM0008K "Black Type"	Meter Cover
G11	QKJM0045 "Silver Type" QKJM0045Y "Black Type"	Meter Filter
G12	QGC1182 "Silver Type" QGC1182K "Black Type"	Case Cover
G13	XTN2+6B	Tapping Screw $\pm 2 \times 6$
G14	XTB4+10BFN "Silver Type" XTB4+10BFZ "Black Type"	Tapping Screw $\pm 4 \times 10$
G15	XTS3+10B	Tapping Screw $\pm 3 \times 10$
G16	XTN3+10B	"
G17	QH1299	Step Screw
G18	QGS0125	Main Name Plate
*For all European areas except United Kingdom.		
	QGS0126	"
*For United Kingdom.		
G19	QKMM0032K	Main Case
G20	QXL1363	Eject Button Assembly
G21	QXL1364	Record Button Assembly
G22	QXL1365	Rewind/Review Button Assembly
G23	QXL1366	Fast Forward/Cue Button Assembly
G24	QXL1367	Playback Button Assembly
G25	QXL1368	Stop Button Assembly
G26	QXL1369	Pause Button Assembly
G27	QMN2554	Operation Lever Shaft
G28	QBT1597	Obstruction Rod Spring
G29	QMR1823	Obstruction Rod
G30	QBP1875	Operation Lever Spring
G31	QXA1044	Operation Button Angle Assembly
G32	QDG1102	Holder Gear
G33	QBW2082	Snap Ring
G34	QML3593	Lock Arm
G35	QBP1900	Holder Spring
G36	QBN7008	Eject Spring
G37	XUB5FT	Stop Ring 5 ϕ
G38	QKFM6005K	Cassette Holder
G39	XTN26+6B	Tapping Screw $\pm 2.6 \times 6$
ACCESSORIES		
A1	RP023A	Connection Cord
A2	QQT2874	Instruction Book
*For all European areas except United Kingdom.		
	QQT2875	"
*For United Kingdom.		
PACKINGS		
P1	QPNM0154	Inside Carton
P2	QPAM0042	Cushion-R
P3	QPAM0043	Cushion-L
P4	XZB40X60A02	Poly Bag
P5	QPG1985	Pad

RS-M260 FRANCAIS

MESURES ET REGLAGES

NOTA: Pour garder l'appareil en bon état de marche, positionner les commutateurs à levier et les commandes dans les positions suivantes, sauf indication contraire.

- Vérifiez que les têtes soient propres.
- Vérifiez que le cabestan et le galet-presseur soient propres.
- Température ambiante admissible: 20±5°C.
- Sélecteur de bande: Normal
- Commutateur de contrôle: Position bande
- Commande de niveau: MAX
- Commande de niveau de sortie: MAX
- Sélecteur de Dolby: OUT
- Commutateur de test de crête: LINE

SECTION	MESURES ET REGLAGES
A Réglage de la position de la tête Condition: * Le mode de lecture et pause	Il y a une plaque de réglage de la tête pour ajuster le contact de bande de la tête en mode de repérage avant ou arrière. 1. Appuyer sur le bouton de lecture (PLAY) et le bouton de pause. 2. Mesurer l'espace qui sépare le galet presseur du cabestan. Valeur normale: 0.5±0.3mm 3. Si la valeur mesurée se trouve hors tolérances, desserrer la vis A, et glisser la plaque de réglage de la tête dans la direction de la flèche (B) pour effectuer le réglage (Voir Fig. 2).
B Azimutage de tête Condition: * Position lecture Equipement: * Voltmètre électronique * Oscilloscope * Bande étalon (azimutage)...QZZCFM * Bande étalon (Fenêtre de passage de la bande avec miroir)...QZZCRD	Réglage de la tête multiple 1. Branchez les appareils comme ci-dessous. (Voir Fig. 3). 2. Lisez la bande étalon d'azimutage (QZZCFM, 8kHz). 3. Réglez la vis d'orientation (B) Fig. 4, de la tête d'enregistrement/lecture pour obtenir le niveau maximal à la sortie LINE OUT. 4. Mesurez les deux canaux, et ajustez les niveaux à égalité de tension de sortie. 5. Après réglage, bloquez la vis par une goutte de vernis.
C Réglage de la hauteur de la tête d'effacement Condition: * Position lecture Equipement: * Bande étalon (Fenêtre de passage de la bande avec miroir)...QZZCRD	1. Retirer les vis (D) et (E) pour remplacer la tête de lecture. (L'écrou (C) étant conçu pour le réglage de la hauteur de la tête d'effacement pour maintenir la performance, ne pas le retirer.) 2. Après avoir remplacé la tête d'effacement, procéder à la vérification du bon déroulement de la bande en écoutant la bande d'essai QZZCRD. Pour tout problème de déroulement de la bande, régler selon la procédure ci-dessous. Réglage 1. Ajuster l'écrou (C) montré à la fig. 5 de sorte que la bande passe correctement sur le guide de la tête d'effacement. 2. Le réglage terminé, bloquer l'écrou (C) avec du vernis.
D Vitesse de défilement Condition: * Position lecture Equipement: * Compteur électronique numérique ou fréquencemètre numérique * Bande étalon...QZZCWAT	Précision de la vitesse de défilement 1. Branchez les appareils comme ci-dessous. (Voir fig. 6). 2. Lisez la bande étalon (QZZCWAT, 3000Hz) et appliquez le signal de sortie au fréquencemètre. 3. Mesurez sa fréquence. 4. Sur la base de 3000Hz, déterminez la valeur à l'aide de la formule. $\text{Précision de vitesse} = \frac{f-3000}{3000} \times 100(\%)$ avec f = valeur mesurée. 5. Effectuez la mesure sur la partie médiane de la bande. Valeur normale: ±1.5% Méthode de réglage 1. Lisez la bande étalon (milieu). 2,3. Ajustez la vis de réglage de vitesse VR indiquée fig. 1 pour que la fréquence devienne égale à 3000Hz. Nota: Utiliser un tournevis non métallique pour régler la vitesse de bande de cet appareil avec précision. Fluctuations de vitesse de défilement Faites les mesures de la même façon que ci-dessus (au début, au milieu et en fin de bande) et déterminez la différence entre les valeurs maximale et minimale, puis calculez comme suit.

SECTION	MESURES ET REGLAGES																																								
	$\text{Fluctuations de vitesse} = \frac{f_1 - f_2}{3000} \times 100(\%)$ $f_1 = \text{valeur maximale}$ $f_2 = \text{valeur minimale}$ Valeur normale: moins de 1%																																								
E Réponse en fréquence à la lecture Condition: * Position lecture * Sélecteur de bande ...position Normal * Commande de niveau de sortie...MAX. Equipement: * Voltmètre électronique * Oscilloscope * Bande étalon...QZZCFM	1. Branchez les appareils comme ci-dessous (Voir Fig. 3). 2. Placez l'appareil en position lecture. 3. Lisez la bande étalon de courbe de réponse (QZZCFM). 4. Mesurez les niveaux de sortie à 315Hz, 12.5kHz, 8kHz, 250Hz, 125Hz et 63Hz et comparez chaque niveau de sortie avec celui de la fréquence étalon de 315Hz, sur la borne LINE OUT. 5. Effectuez la mesure sur les deux canaux. 6. Vérifiez que les valeurs mesurées se situent à l'intérieur du gabarit de courbe de réponse. (Voir Fig. 7). Réglage 1. Si la valeur mesurée se trouve hors tolérances dans la gamme des fréquences élevées, les points de connexion PCB (a) (canal gauche) et (a') (canal droit) doivent être court-circuités. Dans ce cas, les points de connexion (b) (canal gauche) et (b') (canal droit) doivent être ouverts. 2. Procéder aux mêmes mesures données aux étapes 2 à 6 de la section "Mesure" ci-dessus. 3. Si la valeur mesurée diminue dans la gamme des hautes fréquences, comme montré dans la Fig. 8, les points de connexion (b) (canal gauche) et (b') (canal droit) de la plaquette à câblage imprimé devraient être court-circuités (Voir Fig. 12). Valeur de compensation <table border="1"> <tr> <td>4kHz</td> <td>6kHz</td> <td>8kHz</td> <td>10kHz</td> <td>12.5kHz</td> </tr> <tr> <td>Autour de +0.3dB</td> <td>Autour de +0.5dB</td> <td>Autour de +0.7dB</td> <td>Autour de +0.7dB</td> <td>Autour de +0.6dB</td> </tr> </table> 4. Si la valeur mesurée augmente dans la gamme des fréquences élevées, voir figure 9, les points de connexion (a) (canal gauche) et (a') (canal droit) doivent être ouverts. Les points de connexion (b) (canal gauche) et (b') (canal droit) doivent être court-circuités. <table border="1"> <tr> <td>4kHz</td> <td>6kHz</td> <td>8kHz</td> <td>10kHz</td> <td>12.5kHz</td> </tr> <tr> <td>Autour de 0dB</td> <td>Autour de -0.3dB</td> <td>Autour de -0.4dB</td> <td>Autour de -0.5dB</td> <td>Autour de -0.9dB</td> </tr> </table> 5. Si la valeur mesurée diminue à la gamme des moyennes fréquences, comme montré à la Fig. 10, les points de branchement (c) et (c') de la plaquette à câblage imprimé doivent être ouverts (Voir Fig. 12). Valeur de compensation <table border="1"> <tr> <td>700Hz</td> <td>1kHz</td> <td>2kHz</td> <td>4kHz</td> <td>10kHz</td> </tr> <tr> <td>Autour de +0.2dB</td> <td>Autour de +0.4dB</td> <td>Autour de +0.7dB</td> <td>Autour de +0.9dB</td> <td>Autour de +1.2dB</td> </tr> </table> 6. Si la valeur mesurée augmente à la gamme des moyennes fréquences, comme montré à la Fig. 11, les points de branchement (c) et (c') doivent être court-circuités (Voir Fig. 12). Valeur de compensation <table border="1"> <tr> <td>700Hz</td> <td>1kHz</td> <td>2kHz</td> <td>4kHz</td> <td>10kHz</td> </tr> <tr> <td>Autour de -0.2dB</td> <td>Autour de -0.4dB</td> <td>Autour de -0.7dB</td> <td>Autour de -0.9dB</td> <td>Autour de -0.9dB</td> </tr> </table>	4kHz	6kHz	8kHz	10kHz	12.5kHz	Autour de +0.3dB	Autour de +0.5dB	Autour de +0.7dB	Autour de +0.7dB	Autour de +0.6dB	4kHz	6kHz	8kHz	10kHz	12.5kHz	Autour de 0dB	Autour de -0.3dB	Autour de -0.4dB	Autour de -0.5dB	Autour de -0.9dB	700Hz	1kHz	2kHz	4kHz	10kHz	Autour de +0.2dB	Autour de +0.4dB	Autour de +0.7dB	Autour de +0.9dB	Autour de +1.2dB	700Hz	1kHz	2kHz	4kHz	10kHz	Autour de -0.2dB	Autour de -0.4dB	Autour de -0.7dB	Autour de -0.9dB	Autour de -0.9dB
4kHz	6kHz	8kHz	10kHz	12.5kHz																																					
Autour de +0.3dB	Autour de +0.5dB	Autour de +0.7dB	Autour de +0.7dB	Autour de +0.6dB																																					
4kHz	6kHz	8kHz	10kHz	12.5kHz																																					
Autour de 0dB	Autour de -0.3dB	Autour de -0.4dB	Autour de -0.5dB	Autour de -0.9dB																																					
700Hz	1kHz	2kHz	4kHz	10kHz																																					
Autour de +0.2dB	Autour de +0.4dB	Autour de +0.7dB	Autour de +0.9dB	Autour de +1.2dB																																					
700Hz	1kHz	2kHz	4kHz	10kHz																																					
Autour de -0.2dB	Autour de -0.4dB	Autour de -0.7dB	Autour de -0.9dB	Autour de -0.9dB																																					
F Gain à la lecture Condition: * Position lecture * Sélecteur de bande ...position Normal * Commande de niveau de sortie...MAX. Equipement: * Voltmètre électronique * Oscilloscope * Bande étalon...QZZCFM	1. Branchez les appareils comme ci-dessous (Voir Fig. 3). 2. Lisez la partie "niveau standard" de la bande étalon (QZZCFM, 315Hz) et mesurez le niveau de sortie, avec le voltmètre électronique, sur le jack LINE OUT. 3. Effectuez les mesures sur les deux canaux. Valeur normale: Autour de 0.7V Réglage 1. Si la valeur mesurée n'est pas correct, réglez VR1 (canal gauche) et VR2 (canal droit) (Voir Fig. 1). 2. Après réglage, vérifiez à nouveau la "E réponse en fréquence à la lecture".																																								

SECTION	MESURES ET REGLAGES
G Fuites de Prémagnétisation Condition: * Position enregistrement * Sélecteur de bande ...position Normal Equipement: * Voltmètre électronique * Oscilloscope	Réglage (Pour l'amplificateur d'enregistrement) 1. Branchez les appareils comme ci-dessus. 2. Placez l'appareil en position enregistrement. 3. Réglez les bobines de la trappe L20 (canal droit) pour que la mesure soit correcte. Réglage (Pour l'amplificateur de reproduction) 1. Branchez les appareils comme ci-dessus. 2. Placez l'appareil en mode d'enregistrement. 3. Réglez les bobines bouchon L1 (canal droit) de façon à minimiser les valeurs de sortie à LINE-OUT.
H Courant d'effacement Condition: * Position enregistrement * Sélecteur de bande ...position Metal Equipement: * Voltmètre électronique * Oscilloscope	1. Branchez les appareils comme ci-dessus. 2. Placez l'appareil en mode d'enregistrement au point d'essai 9. 3. Déterminer le courant d'effacement. $\text{Courant d'effacement (A)} = \frac{\text{Tension aux bornes de la bobine}}{1(\Omega)}$ Valeur normale: 100 ± 20 mA 4. Si la valeur lue se trouve hors tolérances, réglez VR402 (canal gauche) et VR403 (canal droit) de la bobine de la trappe L20.
I Courant de prémagnétisation Condition: * Position enregistrement * Sélecteur de bande ...position Normal * Position Fe-Cr * Position CrO ₂ * Position Metal * Commande de niveau de sortie...MAX. Equipement: * Voltmètre électronique * Oscilloscope	1. Branchez les appareils selon la Fig. 13. 2. Placez l'appareil en position enregistrement sur la bande "normal" (pour bande normale). 3. Lisez la tension sur le voltmètre électronique. $\text{Courant de prémagnétisation (mA)} = \frac{\text{Tension lue sur voltm. électronique}}{10(\Omega)}$ Valeur normale: 0.7 ± 0.3 mA 4. Réglez VR402 (canal gauche) et VR403 (canal droit) de la bobine de la trappe L20. 5. Positionner le sélecteur de bande sur "Fe-Cr". 6. Vérifiez si la valeur mesurée correspond à la valeur normale. Valeur normale: 1.0 ± 0.3 mA (pour Fe-Cr) 1.6 ± 0.3 mA (pour CrO₂)
J Gain global Condition: * Positions enregistrement/lecture * Sélecteur de bande ...position Normal * Position Fe-Cr * Position CrO ₂ * Position Metal * Commande de niveau de sortie...MAX. * Commande de niveau de sortie...MAX. * Niveaux d'entrée normaux MIC -72±3dB LINE IN -24±3dB Equipement: * Voltmètre électronique * Générateur AF * Atténuateur * Oscilloscope. * Bande étalon vierge ...QZZCRA pour type de bande normale ...QZZCRY pour Fe-Cr ...QZZCRX pour CrO ₂ ...QZZCRZ pour Metal	1. Branchez les appareils comme sur la Fig. 14. 2. Mettre la cassette d'essai (QZZCRA) dans la cassette. 3. Positionner l'appareil en mode d'enregistrement sur chaque position. 4. Appliquer un signal de 1kHz (-24dB) à l'entrée LINE IN. 5. Régler le ATT de telle façon à ce que la tension de sortie à LINE OUT devienne 0.7V. 6. Placez l'appareil en position enregistrement. 7. Effectuer la lecture d'une cassette en position enregistrement. 8. Si la valeur lue se trouve hors tolérances, réglez VR204 (canal gauche), VR205 (canal droit). 9. Recommencez à partir du palier (4). 10. Passer sur chaque position du sélecteur de bande. 11. Changer la bande d'essai sur Fe-Cr ou Metal (QZZCRZ). 12. Placez l'appareil en position enregistrement. 13. Effectuer la lecture d'une cassette en position enregistrement. Valeur normal: Autour de 0.7V Valeur normal: 0.7V ± 1.5dB

	MESURES ET REGLAGES
	<p>Réglage (Pour l'amplificateur d'enregistrement)</p> <ol style="list-style-type: none"> 1. Branchez les appareils comme ci-dessous (voir Fig. 13). 2. Placez l'appareil en position enregistrement. 3. Réglez les bobines de la trappe L205 (canal gauche) et L206 (canal droit) pour que la mesure soit au minimum. (Voir Fig. 1). <p>Réglage (Pour l'amplificateur de reproduction)</p> <ol style="list-style-type: none"> 1. Branchez les appareils comme ci-dessous (Voir Fig. 14). 2. Placer l'appareil en mode d'enregistrement et amener le sélecteur de contrôle sonore à la position TAPE. 3. Régler les bobines bouchon L1 (canal gauche) et L2 (canal droit) de façon à minimiser les valeurs mesurées à la sortie de LINE-OUT.
	<ol style="list-style-type: none"> 1. Branchez les appareils comme ci-dessous (Voir Fig. 15). 2. Placer l'appareil en mode d'enregistrement et mesurer la tension au point d'essai 9. 3. Déterminer le courant d'effacement avec la formule suivante. Courant d'effacement (A) $= \frac{\text{Tension aux bornes de la résistance R403 (V)}}{1 (\Omega)}$ <p style="text-align: center;">Valeur normale: 100 ± 20 mA (position Metal)</p> <ol style="list-style-type: none"> 4. Si la valeur lue se trouve hors tolérances, régler VR403.
	<ol style="list-style-type: none"> 1. Branchez les appareils selon la Fig. 16. 2. Placez l'appareil en position enregistrement, le sélecteur de bande sur "normal" (pour bande normale). 3. Lisez la tension sur le voltmètre électronique et calculez le courant de prémagnétisation selon la formule. Courant de prémagnétisation (A) $= \frac{\text{Tension lue sur voltm. élec. (V)}}{10 (\Omega)}$ <p style="text-align: center;">Valeur normale: 0.7 ± 0.3 mA (position Normal)</p> <ol style="list-style-type: none"> 4. Réglez VR402 (canal gauche) et VR401 (canal droit). 5. Positionner le sélecteur de bande sur chaque position. 6. Vérifiez si la valeur mesurée correspond à la norme. <p style="text-align: center;">Valeur normale: 0.75 ± 0.3 mA (position Fe-Cr) Valeur normale: 1.0 ± 0.3 mA (position CrO₂) Valeur normale: 1.6 ± 0.3 mA (position Metal)</p>
	<ol style="list-style-type: none"> 1. Branchez les appareils comme sur la Fig. 17. 2. Mettre la cassette d'essai (QZZCRA) en place dans le support de la cassette. 3. Positionner l'appareil en mode d'enregistrement, et le sélecteur de bande sur chaque position. 4. Appliquer un signal de 1kHz (-24dB) de l'oscillateur AF, branché à l'ATT, à l'entrée LINE IN. 5. Régler le ATT de telle façon à ce que le niveau de sortie à la fiche "LINE OUT" devienne 0.7V. 6. Placez l'appareil en position enregistrement. 7. Effectuer la lecture d'une cassette enregistrée, et mesurer le niveau de sortie à LINE OUT sur le voltmètre électronique à tubes. <p style="text-align: center;">Valeur normal: Autour de $0.7V \pm 1.5$ dB (position Normal)</p> <ol style="list-style-type: none"> 8. Si la valeur lue se trouve hors tolérances, régler VR203 (canal gauche), VR204 (canal droit). 9. Recommencez à partir du palier (4). 10. Passer sur chaque position du sélecteur de bande. 11. Changer la bande d'essai sur Fe-Cr (QZZCRY), CrO₂ (QZZCRX) ou Metal (QZZCRZ). 12. Placez l'appareil en position enregistrement. 13. Effectuer la lecture d'une cassette enregistrée, et mesurer le niveau de sortie à LINE OUT sur le voltmètre électronique à tubes. <p style="text-align: center;">Valeur normal: $0.7V \pm 1.5$ dB (position Fe-Cr) (position CrO₂) (position Metal)</p>

SECTION	MESURES ET REGLAGES																																																																																										
	<ol style="list-style-type: none"> 14. Si la valeur mesurée ne correspond pas à la norme, réglez de la manière suivante. 15. Réglez l'amplification globale en court-circuitant ou en ouvrant le point du circuit imprimé à la Fig. 18, de telle manière que chacune des positions arrive autour de sa valeur normative. 16. Se référer au tableau suivant pour les valeurs des réglages des amplifications globales. <p>Position Fe-Cr (CANAL GAUCHE)</p> <table border="1"> <tr><td>AMPLIFICATION</td><td>POINT (d)</td><td>POINT (e)</td></tr> <tr><td>FAIBLE</td><td>FERME</td><td>FERME</td></tr> <tr><td>↑</td><td>FERME</td><td>OUVERT</td></tr> <tr><td>↓</td><td>OUVERT</td><td>FERME</td></tr> <tr><td>ELEVE</td><td>OUVERT</td><td>OUVERT</td></tr> </table> <p>Position Fe-Cr (CANAL DROIT)</p> <table border="1"> <tr><td>AMPLIFICATION</td><td>POINT (d')</td><td>POINT (e')</td></tr> <tr><td>FAIBLE</td><td>FERME</td><td>FERME</td></tr> <tr><td>↑</td><td>FERME</td><td>OUVERT</td></tr> <tr><td>↓</td><td>OUVERT</td><td>FERME</td></tr> <tr><td>ELEVE</td><td>OUVERT</td><td>OUVERT</td></tr> </table> <p>Position CrO₂ (CANAL GAUCHE)</p> <table border="1"> <tr><td>AMPLIFICATION</td><td>POINT (f)</td><td>POINT (g)</td></tr> <tr><td>FAIBLE</td><td>FERME</td><td>FERME</td></tr> <tr><td>↑</td><td>FERME</td><td>OUVERT</td></tr> <tr><td>↓</td><td>OUVERT</td><td>FERME</td></tr> <tr><td>ELEVE</td><td>OUVERT</td><td>OUVERT</td></tr> </table> <p>Position CrO₂ (CANAL DROIT)</p> <table border="1"> <tr><td>AMPLIFICATION</td><td>POINT (f')</td><td>POINT (g')</td></tr> <tr><td>FAIBLE</td><td>FERME</td><td>FERME</td></tr> <tr><td>↑</td><td>FERME</td><td>OUVERT</td></tr> <tr><td>↓</td><td>OUVERT</td><td>FERME</td></tr> <tr><td>ELEVE</td><td>OUVERT</td><td>OUVERT</td></tr> </table> <p>Position Metal (CANAL GAUCHE)</p> <table border="1"> <tr><td>AMPLIFICATION</td><td>POINT (h)</td><td>POINT (i)</td></tr> <tr><td>FAIBLE</td><td>FERME</td><td>FERME</td></tr> <tr><td>↑</td><td>FERME</td><td>OUVERT</td></tr> <tr><td>↓</td><td>OUVERT</td><td>FERME</td></tr> <tr><td>ELEVE</td><td>OUVERT</td><td>OUVERT</td></tr> </table> <p>Position Metal (CANAL DROIT)</p> <table border="1"> <tr><td>AMPLIFICATION</td><td>POINT (h')</td><td>POINT (i')</td></tr> <tr><td>FAIBLE</td><td>FERME</td><td>FERME</td></tr> <tr><td>↑</td><td>FERME</td><td>OUVERT</td></tr> <tr><td>↓</td><td>OUVERT</td><td>FERME</td></tr> <tr><td>ELEVE</td><td>OUVERT</td><td>OUVERT</td></tr> </table>	AMPLIFICATION	POINT (d)	POINT (e)	FAIBLE	FERME	FERME	↑	FERME	OUVERT	↓	OUVERT	FERME	ELEVE	OUVERT	OUVERT	AMPLIFICATION	POINT (d')	POINT (e')	FAIBLE	FERME	FERME	↑	FERME	OUVERT	↓	OUVERT	FERME	ELEVE	OUVERT	OUVERT	AMPLIFICATION	POINT (f)	POINT (g)	FAIBLE	FERME	FERME	↑	FERME	OUVERT	↓	OUVERT	FERME	ELEVE	OUVERT	OUVERT	AMPLIFICATION	POINT (f')	POINT (g')	FAIBLE	FERME	FERME	↑	FERME	OUVERT	↓	OUVERT	FERME	ELEVE	OUVERT	OUVERT	AMPLIFICATION	POINT (h)	POINT (i)	FAIBLE	FERME	FERME	↑	FERME	OUVERT	↓	OUVERT	FERME	ELEVE	OUVERT	OUVERT	AMPLIFICATION	POINT (h')	POINT (i')	FAIBLE	FERME	FERME	↑	FERME	OUVERT	↓	OUVERT	FERME	ELEVE	OUVERT	OUVERT
AMPLIFICATION	POINT (d)	POINT (e)																																																																																									
FAIBLE	FERME	FERME																																																																																									
↑	FERME	OUVERT																																																																																									
↓	OUVERT	FERME																																																																																									
ELEVE	OUVERT	OUVERT																																																																																									
AMPLIFICATION	POINT (d')	POINT (e')																																																																																									
FAIBLE	FERME	FERME																																																																																									
↑	FERME	OUVERT																																																																																									
↓	OUVERT	FERME																																																																																									
ELEVE	OUVERT	OUVERT																																																																																									
AMPLIFICATION	POINT (f)	POINT (g)																																																																																									
FAIBLE	FERME	FERME																																																																																									
↑	FERME	OUVERT																																																																																									
↓	OUVERT	FERME																																																																																									
ELEVE	OUVERT	OUVERT																																																																																									
AMPLIFICATION	POINT (f')	POINT (g')																																																																																									
FAIBLE	FERME	FERME																																																																																									
↑	FERME	OUVERT																																																																																									
↓	OUVERT	FERME																																																																																									
ELEVE	OUVERT	OUVERT																																																																																									
AMPLIFICATION	POINT (h)	POINT (i)																																																																																									
FAIBLE	FERME	FERME																																																																																									
↑	FERME	OUVERT																																																																																									
↓	OUVERT	FERME																																																																																									
ELEVE	OUVERT	OUVERT																																																																																									
AMPLIFICATION	POINT (h')	POINT (i')																																																																																									
FAIBLE	FERME	FERME																																																																																									
↑	FERME	OUVERT																																																																																									
↓	OUVERT	FERME																																																																																									
ELEVE	OUVERT	OUVERT																																																																																									
<p>Ⓚ Courbe de réponse globale</p> <p>Condition:</p> <ul style="list-style-type: none"> * Positions enregistrement/lecture * Commande de niveau ...MAX. * Commande niveau de sortie...MAX. * Sélecteur de bande ...position Normal ...position Fe-Cr ...position CrO₂ ...position Metal <p>Equipement:</p> <ul style="list-style-type: none"> * Voltmètre électronique * Générateur AF * Atténuateur * Résistance (600Ω) * Bande étalon vierge ...QZZCRA pour type normal ...QZZCRY pour Fe-Cr ...QZZCRX pour CrO₂ ...QZZCRZ pour Metal 	<p>Nota 1: Avant de mesurer et régler, vérifiez que la courbe de réponse en lecture est correct (pour la méthode de mesure, reportez-vous au paragraphe considéré).</p> <p>Nota 2: La bande d'essai QZZCRA qui sera fournie après juillet 1980 a une sensibilité d'enregistrement plus élevée dans la gamme des moyennes et des hautes fréquences.</p> <ul style="list-style-type: none"> * Ce diagramme indique les valeurs standard pour le nouveau type de QZZCRA lorsque utilisé. * Ce diagramme indique les valeurs standard pour l'ancien type de QZZCRA lorsque utilisé. <p>Le nouveau type de QZZCRA est marqué comme montré sur la Fig. 20.</p> <p>MESURE:</p> <ol style="list-style-type: none"> 1. Branchez les appareils de mesure comme sur la Fig. 17. 2. Mettre la cassette d'essai (QZZCRA) en place dans le support de la cassette. 3. Placez l'appareil en position enregistrement, le sélecteur de bande sur "Normal". 4. Appliquez un signal à 1kHz du générateur AF, à travers l'atténuateur, à l'entrée LINE IN. 5. Réglez l'atténuateur pour que le niveau d'entrée soit inférieur de -20dB au niveau étalon d'enregistrement. 6. A ce moment, le niveau sur LINE OUT est de 0.07V. 7. Enregistrez les fréquences de 50Hz, 200Hz, 1kHz, 4kHz, 8kHz et 13kHz (15kHz pour bande Fe-Cr, CrO₂ Metal) à niveau constant. 8. Lisez cet enregistrement et exprimez en dB les différences entre le niveau de sortie de chaque fréquence et le niveau à 1kHz. 9. S'assurer que la valeur mesurée se trouve dans la page spécifiée dans le diagramme de réponse en fréquences généraux (Voir Fig. 19). 10. Changer la bande d'essai sur Fe-Cr (QZZCRY), CrO₂ (QZZCRX) ou Metal (QZZCRZ). 11. Positionner le sélecteur de bande sur chaque position. 12. Mesurer de la même manière de l'étape 3 à l'étape 8. 13. S'assurer que la valeur mesurée se trouve dans la plage spécifiée dans le diagramme de la réponse en fréquences totale pour les bandes Fe-Cr, CrO₂ et Metal montré dans les figures 21. 																																																																																										

SECTION	MESURES ET REGLAGES
	<p>Réglage-1 Utilisation du courant de polarisation</p> <ol style="list-style-type: none"> 1. Lorsque la courbe de réponse le gabarit entre le médium et l'aigu, comme indiqué par le trait plein de la Fig. 22, augmentez le courant de prémagnétisation en tournant les VR suivants: VR402 (canal gauche), VR401 (canal droit) 2. Lorsqu'elle est inférieure, comme indiqué par la ligne en trait interrompu, réduisez le courant de prémagnétisation en tournant les VR suivants en sens inverse. VR402 (canal gauche), VR401 (canal droit) <p>Nota: Pour la mesure du courant de prémagnétisation, reportez-vous au paragraphe correspondant en page 6.</p> <p style="text-align: center;">Réglage 2—Utilisation des bobines de correction d'enregistrement</p> <p>Lorsque la courbe de réponse est plate dans le médium et croit ou chute fortement dans l'aigu, comme indiqué par la Fig. 23, réglez en tournant les bobines suivantes de correction d'enregistrement avec les bandes normales. L203 (canal gauche), L204 (canal droit)</p>
<p>Ⓛ Indicateur de niveau</p> <p>Condition:</p> <ul style="list-style-type: none"> * Position enregistrement * Commande de niveau ...MAX. * Commande de niveau de sortie...MAX. * Sélecteur de bande ...position Normal <p>Equipement:</p> <ul style="list-style-type: none"> * Voltmètre électronique * Générateur AF * Atténuateur 	<ol style="list-style-type: none"> 1. Branchez les appareils comme sur la Fig. 17. 2. Comme il est montré à la Fig. 24, le branchement de la base de Q102 à la terre arrête les oscillations du multivibrateur instable comprenant Q102 et Q103. 3. Alimenter d'un 1kHz (-24dB) a la fiche "LINE IN", puis pousser le bouton d'enregistrement. 4. Régler le ATT de telle façon à ce que le niveau de sortie à la fiche "LINE OUT" devienne 0.7V (Le niveau d'entrée à cette position est nommé le niveau d'entrée standard). 5. Réglage au "-20dB". A. Réglez l'atténuateur pour que le niveau d'entrée soit inférieur de -20dB au niveau étalon d'enregistrement. B. Réglez VR101 de tel façon que le segment de -20dB s'allume dans la zone de -20dB±0.8dB. (canal droit seulement) (Voir Fig. 25). 6. Réglage au "0dB". A. Régler le ATT de telle façon à ce que le niveau de sortie à la fiche "LINE OUT" devienne 0.7V. B. Réglez VR102 de tel façon que le segment de +1dB s'allume dans la zone de 0±0.2dB du niveau d'entrée standard (Voir Fig. 26). 7. Répéter deux fois les étapes 5 à 6 ci-dessus. 8. Réglez l'ATT et vérifiez si tous les segments s'allument quand le niveau d'un signal d'entrée est augmenté de 10dB au dessus du niveau d'entrée standard (Voir Fig. 27).
<p>Ⓜ Circuit Dolby</p> <p>Condition:</p> <ul style="list-style-type: none"> * Position enregistrement * Commande de niveau LINE IN...MAX. * Commande de niveau de sortie...MAX. <p>Equipement:</p> <ul style="list-style-type: none"> * Voltmètre électronique * Générateur AF * Atténuateur * Oscilloscope * Résistance (600Ω) 	<ol style="list-style-type: none"> 1. Branchez les appareils comme sur la Fig. 28. 2. Placez l'appareil en position enregistrement et le sélecteur Dolby en position OUT, puis appliquez un signal à 5kHz à l'entrée LINE IN pour obtenir -34.5dB sur TP5 (canal gauche) et TP6 (canal droit). 3. Vérifiez que la valeur en position IN du sélecteur Dolby augmente de 8 (±2.5)dB par rapport à celle obtenue en position OUT.

RS-M260 DEUTSCH

Messungen und Einstellung

Anm.: Für gute Meßbedingungen sorgen. Falls nicht anders angegeben, die Schalter und Regler in folgende Positionen stellen.

- Für saubere Köpfe sorgen.
- Für saubere Tonwelle und Andruckrolle sorgen.
- Auf normale Raumtemperatur achten: $20 \pm 5^\circ\text{C}$.
- Band Schalter: Normal.
- Monitorschalter: Band-Position.

- Eingangsregler: MAX
- Ausgangsregler: MAX
- Dolby-Schalter: Aus
- Spitzenwertschalter: LINE

Gegenstand	Messung und Einstellung
A Tonkopf-Positionierung Bedingung: * Wiedergabe und Pause	(Die Tonkopf-Positionierplatte dient zum Einstellen des Kontakts zwischen Tonkopf und Band während der Betriebszustände „Cue“ und „Review“.) 1. Die Wiedergabetaste PLAY und die Pausetaste drücken. 2. Den Abstand zwischen der Andruckrolle und der Tonwelle messen. <div style="border: 1px solid black; padding: 2px; width: fit-content; margin: 5px auto;">NORMALWERT: $0,5 \pm 0,3\text{mm}$</div> 3. Falls der Meßwert außerhalb des Toleranzbereichs liegt, die Schraube (A) lösen und die Tonkopf-Positionierplatte in Pfeilrichtung (B) schieben, um den Kopfkontakt einzustellen (Siehe Fig. 2).
B Senkrechtstellen des Kopfes Bedingung: * Wiedergabe Meßgerät: * Röhrenvoltmeter * Oszillograf * Testband...QZZCFM * Testband (Bandlaufweg-Betrachtungsvorrichtung mit Spiegel)...QZZCRD	Justage des Senkrechtstellen des Kopfes 1. Den Meßaufbau zeigt Fig. 3. 2. Testband (QZZCFM, 8kHz) wiedergeben. 3. Einstellschraube (B) (Fig. 4) auf maximale Ausgangsspannung einstellen. 4. Beide Kanäle überprüfen und auf gleiche Ausgangsspannung einstellen. 5. Nach dem Abgleich Einstellschraube mit Lack sichern.
C Einstellung der Löschkopfhöhe Bedingung: * Wiedergabe Meßgerät: * Testband (Bandlaufweg-Betrachtungsvorrichtung mit Spiegel)...QZZCRD	1. Die Schrauben (D) und (E) lösen und den Löschkopf ersetzen. (Die Mutter (C) dient zur Einstellung der Löschkopfhöhe und darf nicht gelöst werden.) 2. Nachdem der Löschkopf ausgewechselt wurde, das Testband QZZCRD abspielen. Sollten irgendwelche Probleme beim Bandtransport auftreten, ist auf unten beschriebene Weise die Einstellung vorzunehmen. Abgleich 1. Die Mutter (C) (siehe Fig. 5) so justieren, daß das Band sich nicht verwickelt oder von der Bandführung des Löschkopfes verzogen wird. 2. Nach der Einstellung die Mutter (C) mit Lack sichern.
D Bandgeschwindigkeit Bedingung: * Wiedergabe Meßgerät: * Elektronischer Digitalzähler * Testband...QZZCWAT	Genauigkeit der Bandgeschwindigkeit 1. Den Meßaufbau zeigt Fig. 6. 2. Testband (QZZCWAT 3000Hz) wiedergeben und Ausgangssignal dem Zähler zuführen. 3. Frequenz messen. 4. Beträgt die auf dem Testband aufgezeichnete Frequenz 3000Hz, so ergibt sich die Genauigkeit nach folgender Formel: $\text{Genauigkeit der Bandgeschwindigkeit} = \frac{f - 3000}{3000} \times 100(\%)$ worin f die gemessene Frequenz ist. 5. Die Messung soll im mittleren Teil des Bandes erfolgen. <div style="border: 1px solid black; padding: 2px; width: fit-content; margin: 5px auto;">NORMALWERT: $\pm 1,5\%$</div> Einstellung: 1. Den mittleren Teil des Testbandes wiedergeben. 2,3. Die Einstellschraube VR Vgl Fig. 1 so verstellen, daß eine Frequenz von 3000Hz angezeigt wird. Anm: Verwenden Sie einen nichtmetallischen Schraubenzieher wenn Sie die Bandgeschwindigkeit justieren. Schwankung der Bandgeschwindigkeit: Messung, wie oben beschrieben für Anfang, mittleren Teil und Ende des Testbandes wiederholen und Schwankung wie folgt bestimmen:

Gegenstand	Messung und Einstellung																																								
	$\text{Schwankung} = \frac{f_1 - f_2}{3000} \times 100(\%)$ $f_1 = \text{Maximalwert}$ $f_2 = \text{Minimalwert}$ <div style="border: 1px solid black; padding: 2px; width: fit-content; margin: 5px auto;">NORMALWERT: Weniger als 1%</div>																																								
E Frequenzgang bei Wiedergabe Bedingung: * Wiedergabe * Band Schalter ...Normal position * Ausgangsregler: MAX. Meßgerät: * Röhrenvoltmeter * Oszillograf * Testband...QZZCFM	1. Den Meßaufbau zeigt Fig. 3. 2. Gerät auf "wiedergabe" schalten. 3. Frequenzgang-Testband QZZCFM wiedergeben. 4. Ausgangsspannungen bei 315kHz, 12,5kHz, 8kHz, 250Hz, 125Hz und 63Hz mit Ausgangsspannung der Standard Frequenz 315Hz vergleichen. 5. Messungen an beiden Kanälen durchführen. 6. Prüfen, ob die Werte innerhalb der in Fig. 7 dargestellten Kurven liegen. Abgleich 1. Sollte der Meßwert im hohen Frequenzbereich vom Sollwert abweichen, die Leiterplattenstellen (a) (linker Kanal) und (a') (rechter Kanal) kurzschließen (Fig. 12). Die Stellen (b) (linker Kanal) und (b') (rechter Kanal) sind dabei zu unterbrechen. 2. Die Messung wiederholen (Schritte 2 bis 6). 3. Falls bei hohen Frequenzen ein kleinerer Wert gemessen wird (siehe Fig. 8), müssen die Leiterplatten-Anschlußpunkte (b) (linker Kanal) und (b') (rechter Kanal) kurzgeschlossen werden (Siehe Fig. 12). Kompensationswert <table border="1" style="width: 100%; text-align: center;"> <tr> <td>4kHz</td> <td>6kHz</td> <td>8kHz</td> <td>10kHz</td> <td>12,5kHz</td> </tr> <tr> <td>Ungefähr +0,3dB</td> <td>Ungefähr +0,5dB</td> <td>Ungefähr +0,7dB</td> <td>Ungefähr +0,7dB</td> <td>Ungefähr +0,6dB</td> </tr> </table> 4. Falls der Meßwert im hohen Frequenzbereich ansteigt (Fig. 9) die Leiterplattenstellen (a) (linker Kanal) und (a') (rechter Kanal) unterbrechen. Die Stellen (b) (linker Kanal) und (b') (rechter Kanal) müssen kurzgeschlossen werden. <table border="1" style="width: 100%; text-align: center;"> <tr> <td>4kHz</td> <td>6kHz</td> <td>8kHz</td> <td>10kHz</td> <td>12,5kHz</td> </tr> <tr> <td>Ungefähr 0dB</td> <td>Ungefähr -0,3dB</td> <td>Ungefähr -0,3dB</td> <td>Ungefähr -0,4dB</td> <td>Ungefähr -0,7dB</td> </tr> </table> 5. Falls der Meßwert bei mittleren Frequenzen abfällt, sind die Stellen (c) und (c') auf der Leiterplatte zu unterbrechen. (Siehe Fig. 10, 12). Kompensationswert <table border="1" style="width: 100%; text-align: center;"> <tr> <td>700Hz</td> <td>1kHz</td> <td>2kHz</td> <td>4kHz</td> <td>10kHz</td> </tr> <tr> <td>Ungefähr +0,2dB</td> <td>Ungefähr +0,4dB</td> <td>Ungefähr +0,7dB</td> <td>Ungefähr +0,9dB</td> <td>Ungefähr +0,9dB</td> </tr> </table> 6. Falls der Meßwert bei mittleren Frequenzen steigt, sind die Stellen (c) und (c') auf der Leiterplatte kurzzuschließen. (Siehe Fig. 11, 12). Kompensationswert <table border="1" style="width: 100%; text-align: center;"> <tr> <td>700Hz</td> <td>1kHz</td> <td>2kHz</td> <td>4kHz</td> <td>10kHz</td> </tr> <tr> <td>Ungefähr -0,2dB</td> <td>Ungefähr -0,4dB</td> <td>Ungefähr -0,7dB</td> <td>Ungefähr -0,9dB</td> <td>Ungefähr -0,9dB</td> </tr> </table>	4kHz	6kHz	8kHz	10kHz	12,5kHz	Ungefähr +0,3dB	Ungefähr +0,5dB	Ungefähr +0,7dB	Ungefähr +0,7dB	Ungefähr +0,6dB	4kHz	6kHz	8kHz	10kHz	12,5kHz	Ungefähr 0dB	Ungefähr -0,3dB	Ungefähr -0,3dB	Ungefähr -0,4dB	Ungefähr -0,7dB	700Hz	1kHz	2kHz	4kHz	10kHz	Ungefähr +0,2dB	Ungefähr +0,4dB	Ungefähr +0,7dB	Ungefähr +0,9dB	Ungefähr +0,9dB	700Hz	1kHz	2kHz	4kHz	10kHz	Ungefähr -0,2dB	Ungefähr -0,4dB	Ungefähr -0,7dB	Ungefähr -0,9dB	Ungefähr -0,9dB
4kHz	6kHz	8kHz	10kHz	12,5kHz																																					
Ungefähr +0,3dB	Ungefähr +0,5dB	Ungefähr +0,7dB	Ungefähr +0,7dB	Ungefähr +0,6dB																																					
4kHz	6kHz	8kHz	10kHz	12,5kHz																																					
Ungefähr 0dB	Ungefähr -0,3dB	Ungefähr -0,3dB	Ungefähr -0,4dB	Ungefähr -0,7dB																																					
700Hz	1kHz	2kHz	4kHz	10kHz																																					
Ungefähr +0,2dB	Ungefähr +0,4dB	Ungefähr +0,7dB	Ungefähr +0,9dB	Ungefähr +0,9dB																																					
700Hz	1kHz	2kHz	4kHz	10kHz																																					
Ungefähr -0,2dB	Ungefähr -0,4dB	Ungefähr -0,7dB	Ungefähr -0,9dB	Ungefähr -0,9dB																																					
F Wiedergabe-Verstärkung Bedingung: * Wiedergabe * Band Schalter ...Normal position * Ausgangsregler: MAX. Meßgerät: * Röhrenvoltmeter * Oszillograf * Testband...QZZCFM	1. Den Meßaufbau zeigt Fig. 3. 2. Standard-Frequenz (QZZCFM 315Hz) vom Testband wiedergeben und Ausgangsspannung messen. 3. Messung an beiden Kanälen durchführen. <div style="border: 1px solid black; padding: 2px; width: fit-content; margin: 5px auto;">NORMALWERT: Ungefähr 0,7V</div> Einstellung: 1. Abweichungen können durch Abgleich von VR1 (Linker Kanal) und VR2 (Rechter Kanal) (S. Fig. 1) korrigiert werden. 2. Nach erfolgtem Abgleich ist der Frequenzgang bei Wiedergabe erneut zu kontrollieren.																																								

Gegenstand	Messung und Einstellung
G Störstrahlung der Vormagnetisierung Bedingung: * Aufnahme * Band Schalter ...Metal position Meßgerät: * Elektronisches Voltmeter * Oszillograf	Abgleich (zum Aufnahmeverstärker) 1. Den Meßaufbau zeigt Fig. 13. 2. Gerät auf Aufnahme schalten. 3. Sperrkreispulen L205 (Linker Kanal) und L206 (Rechter Kanal) so abgleichen daß der Meßwert mir... Abgleich (zum Wiedergabeverstärker) 1. Den Meßaufbau zeigt Fig. 14. 2. Auf Aufnahme schalten und den Meßwert ablesen. 3. Die Filterspulen L1 (linker Kanal) und L2 (rechter Kanal) so abgleichen, daß an LINE OUT der klei...
H Löschstrom Bedingung: * Aufnahme * Betriebsart "Metalband" Meßgerät: * Röhrenvoltmeter * Oszillograf	1. Den Meßaufbau zeigt Fig. 15. 2. Gerät auf Aufnahme schalten und den Meßwert ablesen. 3. Löschstrom nach folgender Formel berechnen: $\text{Löschstrom (A)} = \frac{\text{Die Spannung über beide Kanäle}}{1 (\Omega)}$ <div style="border: 1px solid black; padding: 2px; width: fit-content; margin: 5px auto;">NORMALWERT: $100 \pm 20 - 5 \text{ mA}$</div> 4. Abweichungen können durch Abgleich... werden.
I Vormagnetisierung Bedingung: * Aufnahme * Band Schalter ...Normal position ...Fe-Cr position ...CrO ₂ position ...Metal position Meßgerät: * Röhrenvoltmeter * Oszillograf	1. Den Meßaufbau zeigt Fig. 16. 2. Gerät auf "Aufnahme" und Bandw... schalten. 3. Spannung vom Röhrenvoltmeter ab... r... $\text{Vormagnetisierungsstrom (A)} = \frac{\text{Spannung am Röhrenvoltmeter}}{10 (\Omega)}$ <div style="border: 1px solid black; padding: 2px; width: fit-content; margin: 5px auto;">NORMALWERT: $0,7 \pm 0,3 \text{ mA}$</div> 4. VR402 (Linker Kanal) und VR401 (Rechter Kanal) so einstellen, daß der Meßwert im vorg... liegt. <div style="border: 1px solid black; padding: 2px; width: fit-content; margin: 5px auto;">NORMALWERT: $0,75 \pm 0,3 \text{ mA}$ $1,0 \pm 0,3 \text{ mA}$ $1,6 \pm 0,3 \text{ mA}$</div>
J Gesamt-Verstärkung Bedingung: * Band Schalter ...Normal position ...Fe-Cr position ...CrO ₂ position ...Metal position * Eingangsregler...MAX. * Ausgangsregler...MAX. * Aufnahme und Wiedergabe * Standard-Eingangspegel Mikrofon -72±3dB NF-Eingang -24±3dB Meßgerät: * Röhrenvoltmeter * NF-Generator * Abschwächer * Oszillograf * Testband (Leerband)	1. Den Meßaufbau zeigt Fig. 17. 2. Testband (QZZCRA) in das Cassette... 3. Gerät auf "Aufnahme" und Bandwa... schalten. 4. Über den Abschwächer 1kHz-Signa... Generator dem IN-Eingang zuführen. 5. Den Abschwächer so einstellen, daß der Monitorpegel an LINE OUT 0,7V wir... 6. Dieses signal auf Testband aufneh... 7. Die Aufnahme wiedergeben, und de... OUT am Röhrenvoltmeter ablesen. <div style="border: 1px solid black; padding: 2px; width: fit-content; margin: 5px auto;">NORMALWERT: $0,7 \text{ V} \pm 1,5 \text{ dB}$</div> 8. Falls der gemessene Wert nicht der... den VR abgleichen. 9. Ab Punkt 3 wiederholen. 10. Den Bandsortenwähler in jede Posi... 11. Nacheinander das Fe-Cr Testband (L... band (QZZCRX) und das Metallparti... benutzen. 12. Gerät auf Aufnahme schalten. 13. Die Aufnahme wiedergeben, und de... OUT am Röhrenvoltmeter ablesen. <div style="border: 1px solid black; padding: 2px; width: fit-content; margin: 5px auto;">NORMALWERT: $0,7 \text{ V} \pm 1,5 \text{ dB}$</div>

Messung und Einstellung
<p>Abgleich (zum Aufnahmeverstärker)</p> <ol style="list-style-type: none"> Den Meßaufbau zeigt Fig. 13. Gerät auf Aufnahme schalten. Sperrkreisspulen L205 (Linker Kanal) und L206 (Rechter Kanal) so abgleichen daß der Meßwert minimal wird. (S. Fig. 1). <p>Abgleich (zum Wiedergabeverstärker)</p> <ol style="list-style-type: none"> Den Meßaufbau zeigt Fig. 14. Auf Aufnahme schalten und den Monitor-Schalter auf „TAPE“ stellen. Die Filterspulen L1 (linker Kanal) und L2 (rechter Kanal) so abgleichen, daß an LINE OUT der kleinste Wert gemessen wird.
<ol style="list-style-type: none"> Den Meßaufbau zeigt Fig. 15. Gerät auf Aufnahme schalten und Spannung am Meßpunkt 9 ablesen. Löschstrom nach folgender Formel ermitteln: Löschstrom (A) $= \frac{\text{Die Spannung über beide Enden von R403}}{1 (\Omega)}$ <p>NORMALWERT: 100 ± 20 mA (Metal position)</p> <ol style="list-style-type: none"> Abweichungen können durch Abgleich von VR403 korrigiert werden.
<ol style="list-style-type: none"> Den Meßaufbau zeigt Fig. 16. Gerät auf „Aufnahme“ und Bandwahlschalter auf „Normal“ schalten. Spannung vom Röhrenvoltmeter ablesen und Vormagnetisierungsstrom nach folgender Formel berechnen: Vormagnetisierungsstrom (A) = $\frac{\text{Spannung am Röhrenvoltmeter (V)}}{10 (\Omega)}$ <p>NORMALWERT: 0.7 ± 0.3 mA (Normal position)</p> <ol style="list-style-type: none"> VR402 (Linker Kanal) und VR401 (Rechter Kanal) abgleichen. Den Bandsortenwähler in jede Position stellen. Überprüfen, ob der Meßwert im vorgeschriebenen Bereich liegt. <p>NORMALWERT: 1.0 ± 0.3 mA (Fe-Cr position) 1.6 ± 0.3 mA (metal position)</p>
<ol style="list-style-type: none"> Den Meßaufbau zeigt Fig. 17. Testband (QZZCRA) in das Cassettenfach einsetzen. Gerät auf „Aufnahme“ und Bandwahlschalter auf „Normal“ schalten. Über den Abschwächer 1 kHz-Signal (-24dB) vom NF-Generator dem IN-Eingang zuführen. Den Abschwächer so einstellen, daß der Quellen-Monitorpegel an LINE OUT 0,7V wird. Dieses signal auf Testband aufnehmen. Die Aufnahme wiedergeben, und den Ausgangspegel an LINE OUT am Röhrenvoltmeter ablesen. <p>NORMALWERT: $0.7V \pm 1,5$ dB (Normal position)</p> <ol style="list-style-type: none"> Falls der gemessene Wert nicht der Toleranz liegt, die folgenden VR abgleichen. VR203 (L-CH) VR204 (R-CH) Ab Punkt 3 wiederholen. Den Bandsortenwähler in jede Position stellen. Nacheinander das Fe-Cr Testband (QZZCRY), das CrO₂ Testband (QZZCRX) und das Metallpartikel-Testband (QZZCRZ) benutzen. Gerät auf Aufnahme schalten. Die Aufnahme wiedergeben, und den Ausgangspegel an LINE OUT am Röhrenvoltmeter ablesen. <p>NORMALWERT: $0.7V \pm 1,5$ dB (Fe-Cr position) $0.7V \pm 1,5$ dB (CrO₂ position) $0.7V \pm 1,5$ dB (Metal position)</p>

Gegenstand	Messung und Einstellung																																																																																																												
	<ol style="list-style-type: none"> Falls der meßwert nicht im vorgeschriebenen Bereich liegt, auf folgende Weise einstellen. Die Gesamtverstärkung durch Kurzschließen bzw. Unterbrechen der in Fig. 18, gezeigten Leiterbahnenstelle so einstellen, daß die Sollwerte angenähert werden. Nehmen Sie zur Einstellung der Gesamtverstärkung die untenstehenden Tabellen zur Hand. <table border="1"> <thead> <tr> <th colspan="3">Fe-Cr position (LINKER KANAL)</th> <th colspan="3">Fe-Cr position (RECHTER KANAL)</th> </tr> <tr> <th>Verstärkung</th> <th>Punkt (d)</th> <th>Punkt (e)</th> <th>Verstärkung</th> <th>Punkt (d')</th> <th>Punkt (e')</th> </tr> </thead> <tbody> <tr> <td>Gering</td> <td>Geschlossen</td> <td>Geschlossen</td> <td>Gering</td> <td>Geschlossen</td> <td>Geschlossen</td> </tr> <tr> <td>↑</td> <td>Geschlossen</td> <td>Offen</td> <td>↑</td> <td>Geschlossen</td> <td>Offen</td> </tr> <tr> <td>↓</td> <td>Offen</td> <td>Geschlossen</td> <td>↓</td> <td>Offen</td> <td>Geschlossen</td> </tr> <tr> <td>Hoch</td> <td>Offen</td> <td>Offen</td> <td>Hoch</td> <td>Offen</td> <td>Offen</td> </tr> </tbody> </table> <table border="1"> <thead> <tr> <th colspan="3">CrO₂ position (LINKER KANAL)</th> <th colspan="3">CrO₂ position (RECHTER KANAL)</th> </tr> <tr> <th>Verstärkung</th> <th>Punkt (f)</th> <th>Punkt (g)</th> <th>Verstärkung</th> <th>Punkt (f')</th> <th>Punkt (g')</th> </tr> </thead> <tbody> <tr> <td>Gering</td> <td>Geschlossen</td> <td>Geschlossen</td> <td>Gering</td> <td>Geschlossen</td> <td>Geschlossen</td> </tr> <tr> <td>↑</td> <td>Geschlossen</td> <td>Offen</td> <td>↑</td> <td>Geschlossen</td> <td>Offen</td> </tr> <tr> <td>↓</td> <td>Offen</td> <td>Geschlossen</td> <td>↓</td> <td>Offen</td> <td>Geschlossen</td> </tr> <tr> <td>Hoch</td> <td>Offen</td> <td>Offen</td> <td>Hoch</td> <td>Offen</td> <td>Offen</td> </tr> </tbody> </table> <table border="1"> <thead> <tr> <th colspan="3">Metal position (LINKER KANAL)</th> <th colspan="3">Metal position (RECHTER KANAL)</th> </tr> <tr> <th>Verstärkung</th> <th>Punkt (h)</th> <th>Punkt (i)</th> <th>Verstärkung</th> <th>Punkt (h')</th> <th>Punkt (i')</th> </tr> </thead> <tbody> <tr> <td>Gering</td> <td>Geschlossen</td> <td>Geschlossen</td> <td>Gering</td> <td>Geschlossen</td> <td>Geschlossen</td> </tr> <tr> <td>↑</td> <td>Geschlossen</td> <td>Offen</td> <td>↑</td> <td>Geschlossen</td> <td>Offen</td> </tr> <tr> <td>↓</td> <td>Offen</td> <td>Geschlossen</td> <td>↓</td> <td>Offen</td> <td>Geschlossen</td> </tr> <tr> <td>Hoch</td> <td>Offen</td> <td>Offen</td> <td>Hoch</td> <td>Offen</td> <td>Offen</td> </tr> </tbody> </table>	Fe-Cr position (LINKER KANAL)			Fe-Cr position (RECHTER KANAL)			Verstärkung	Punkt (d)	Punkt (e)	Verstärkung	Punkt (d')	Punkt (e')	Gering	Geschlossen	Geschlossen	Gering	Geschlossen	Geschlossen	↑	Geschlossen	Offen	↑	Geschlossen	Offen	↓	Offen	Geschlossen	↓	Offen	Geschlossen	Hoch	Offen	Offen	Hoch	Offen	Offen	CrO ₂ position (LINKER KANAL)			CrO ₂ position (RECHTER KANAL)			Verstärkung	Punkt (f)	Punkt (g)	Verstärkung	Punkt (f')	Punkt (g')	Gering	Geschlossen	Geschlossen	Gering	Geschlossen	Geschlossen	↑	Geschlossen	Offen	↑	Geschlossen	Offen	↓	Offen	Geschlossen	↓	Offen	Geschlossen	Hoch	Offen	Offen	Hoch	Offen	Offen	Metal position (LINKER KANAL)			Metal position (RECHTER KANAL)			Verstärkung	Punkt (h)	Punkt (i)	Verstärkung	Punkt (h')	Punkt (i')	Gering	Geschlossen	Geschlossen	Gering	Geschlossen	Geschlossen	↑	Geschlossen	Offen	↑	Geschlossen	Offen	↓	Offen	Geschlossen	↓	Offen	Geschlossen	Hoch	Offen	Offen	Hoch	Offen	Offen
Fe-Cr position (LINKER KANAL)			Fe-Cr position (RECHTER KANAL)																																																																																																										
Verstärkung	Punkt (d)	Punkt (e)	Verstärkung	Punkt (d')	Punkt (e')																																																																																																								
Gering	Geschlossen	Geschlossen	Gering	Geschlossen	Geschlossen																																																																																																								
↑	Geschlossen	Offen	↑	Geschlossen	Offen																																																																																																								
↓	Offen	Geschlossen	↓	Offen	Geschlossen																																																																																																								
Hoch	Offen	Offen	Hoch	Offen	Offen																																																																																																								
CrO ₂ position (LINKER KANAL)			CrO ₂ position (RECHTER KANAL)																																																																																																										
Verstärkung	Punkt (f)	Punkt (g)	Verstärkung	Punkt (f')	Punkt (g')																																																																																																								
Gering	Geschlossen	Geschlossen	Gering	Geschlossen	Geschlossen																																																																																																								
↑	Geschlossen	Offen	↑	Geschlossen	Offen																																																																																																								
↓	Offen	Geschlossen	↓	Offen	Geschlossen																																																																																																								
Hoch	Offen	Offen	Hoch	Offen	Offen																																																																																																								
Metal position (LINKER KANAL)			Metal position (RECHTER KANAL)																																																																																																										
Verstärkung	Punkt (h)	Punkt (i)	Verstärkung	Punkt (h')	Punkt (i')																																																																																																								
Gering	Geschlossen	Geschlossen	Gering	Geschlossen	Geschlossen																																																																																																								
↑	Geschlossen	Offen	↑	Geschlossen	Offen																																																																																																								
↓	Offen	Geschlossen	↓	Offen	Geschlossen																																																																																																								
Hoch	Offen	Offen	Hoch	Offen	Offen																																																																																																								
<p>Ⓚ Gesamt-frequenzgang</p> <p>Bedingung:</p> <ul style="list-style-type: none"> * Aufnahme und Wiedergabe * Eingangsregler...MAX. * Ausgangsregler...MAX. * Bandwahlschalter ...Normal position * ...Fe-Cr position * ...CrO₂ position * ...Metal position <p>Meßgerät:</p> <ul style="list-style-type: none"> * Röhrenvoltmeter * NF-Generator * Abschwächer * Widerstand (600Ω) * Testband (Leerband) QZZCRA für Normal * QZZCRY für Fe-Cr * QZZCRX für CrO₂ * QZZCRZ für Metal 	<p>Anm. 1: Vor Messung und Abgleich des Gesamtfrequenzganges ist sicherzustellen, daß der Frequenzgang bei Wiedergabe korrekt ist (Vgl. entspr. Abschnitt).</p> <p>Anm. 2: Das ab Juli 1980 erhältliche Testband QZZCRA hat eine höhere Aussteuerbarkeit im mittleren und hohen Frequenzbereich. * Diese Werte gelten für das neue Testband QZZCRA. * Diese Werte gelten für das alte Testband QZZCRA. Das neue Testband QZZCRA ist wie in Fig. 20 gekennzeichnet.</p> <p>MESSUNG:</p> <ol style="list-style-type: none"> Den Meßaufbau zeigt Fig. 17. Testband (QZZCRA) in das Cassettenfach einsetzen. Gerät auf „Aufnahme“ und Bandwahlschalter auf „Normal“ schalten. 1 kHz vom NF-Generator über den Abschwächer dem NF-Eingang zuführen. Den Abschwächer so einstellen, daß der Ausgangspegel -20dB des Stand-Aufnahmepegels beträgt. Zu diesem Zeitpunkt beträgt der Ausgangspegel 0,07V. Bei dem gleichen Pegel sind die Frequenzen 50Hz, 200Hz, 1kHz, 4kHz, 8kHz und 13kHz (15kHz für CrO₂ band oder Fe-Cr band, 16kHz für Metal band) aufzuehmen. Diese Aufnahme wiedergeben und dabei die Abweichungen der Pegel der einzelnen Frequenzen vom 1kHz-Pegel in dB bestimmen. Überprüfen, ob der Meßwert innerhalb des Bereichs liegt, der in dem Frequenzgangdiagramm angegeben ist (S. Fig. 19). Nacheinander das Fe-Cr Testband (QZZCRY), das CrO₂ Testband (QZZCRX) und das Metal-Testband (QZZCRZ) benutzen. Den Bandsortenwähler in jede Position stellen. Bei der Messung von Schritt 3 bis 8 auf die gleiche Weise vorgehen. Überzeugen Sie sich, ob der gemessene Wert in dem angegebenen Bereich liegt. (Siehe Diagramm für die Frequenzgänge von Fe-Cr, CrO₂ und Metal bande, Fig. 21). 																																																																																																												

Gegenstand	Messung und Einstellung
	<p>Abgleich-1 mit Vormagnetisierungsstrom</p> <ol style="list-style-type: none"> Werden die mittleren und hohen Frequenzen gemäß der durchgezogene Linie in Fig. 22 zu stark wiedergegeben, so ist der Vormagnetisierungsstrom durch Drehen, die folgenden VR zu erhöhen. VR402 (linker Kanal), VR401 (rechter Kanal) Erfolgt ein Abfall, wie ihn die Strichlinie in Fig. 22 zeigt, so ist an diesen Reglern entgegen der Pfeilrichtung zu drehen, die folgenden VR zu erhöhen. VR402 (linker Kanal), VR401 (rechter Kanal) <p>Anm.: Für die Messung des Vormagnetisierungsstromes sei auf den Abschnitt "● Vormagnetisierung" hingewiesen.</p> <p>Abgleich-2 mit der Entzerrerspule zur Aufnahme-Entzerrung Verläuft der Frequenzgang bei mittleren Frequenzen flach und zeigt bei höheren Frequenzen einen scharfen Anstieg oder Abfall entsprechend Fig. 23 die folgenden Korrekturspulen zu erhöhen. L203 (L-CH), L204 (R-CH)</p>
<p>● Fluoreszenzmeter</p> <p>Bedingung:</p> <ul style="list-style-type: none"> * Aufnahme * Eingangsregler...MAX. * Ausgangsregler...MAX. * Bandwahlschalter ...Normal position <p>Meßgerät:</p> <ul style="list-style-type: none"> * Röhrenvoltmeter * NF-Generator * Abschwächer 	<ol style="list-style-type: none"> Den Meßaufbau zeigt Fig. 17. Wie aus Fig. 24, ersichtlich, hört der astabile, aus den Transistoren Q102 und Q103 bestehende Multivibrator zu schwingen auf, wenn der Base des Q102 mit Masse verbunden wird. Signal vor 1kHz (-24dB) an die Line IN-Buchse eingeben und die Aufnahmetaste drücken. ATT so abstimmen, daß der Ausgangspegel an der LINE OUT-Buchse 0,7V wird. (Der Eingangspegel in dieser Stellung wird als Standardpegel bezeichnet). Justierung auf "-20dB". A. Den Abschwächer so einstellen, daß der Eingangspegel -20dB des Stand-Aufnahmepegels beträgt. B. VR101 so abgleichen, daß im Bereich von -20dB±0,8dB das Segment -20dB aufleuchtet (NUR LINKER KANAL) (S. Fig. 25). Justierung auf "0dB". A. ATT so abstimmen, daß der Ausgangspegel an der LINE OUT-Buchse, 0,7V wird. B. VR102 so abgleichen, daß im Bereich von ±0,2dB um den Standardpegel das Segment +1dB aufleuchtet (S. Fig. 26). Die Anleitungsschritte 5 bis 6 zweimal wiederholen. Die ATT einstellen; kontrollieren, ob alle Segmente aufleuchten, wenn der Eingangspegel 10dB höher als der Standardpegel ist (S. Fig. 27).
<p>Ⓜ Dolby-Schaltung</p> <p>Bedingung:</p> <ul style="list-style-type: none"> * Aufnahme * Eingangsregler...MAX. * Ausgangsregler...MAX. <p>Meßgerät:</p> <ul style="list-style-type: none"> * Röhrenvoltmeter * NF-Generator * Abschwächer * Oszillograf * Widerstand (600Ω) 	<ol style="list-style-type: none"> Den Meßaufbau zeigt Fig. 28. Gerät in Stellung "Aufnahme" betreiben und Dolby-Schalter ausschalten. Dem NF-Eingang ein 5kHz-Signal zuführen, daß an TP5 (Linker Kanal) und TP6 (Rechter Kanal) -34,5dB erhalten werden. Prüfen, ob das Signal bei eingeschaltetem Dolby-Schalter um 8 (±2,5)dB größer ist als bei ausgeschaltetem Dolby-Schalter.

Parts Change Notice

(D)...For all European areas except United Kingdom. (N)...For Asia, Latin America, Middle East and Africa areas.
(B)...For United Kingdom.

Model No.

RS-M260

Please revise the original parts list in the Service Manual to conform to the change(s) shown herein. If new part numbers are shown, be sure to use them when ordering parts.

Reason for Change		*The circled item indicates the reason. If no marking, see the Notes in the bottom column.			
1. Improve performance					
2. Change of material or dimension					
3. To meet approved specification					
4. Standardization					
5. Addition					
6. Deletion					
7. Correction					
8. Other					
Interchangeability Code		**The circled item indicates the interchangeability. If no marking, see the Notes in the bottom column.			
	Parts	Set Production			
A	Original	Early			Original or new parts may be used in early or late production set. Use original parts until exhausted, then stock new parts.
	New	Late			
B	Original	Early			Original parts may be used in early production sets only. New parts may be used in early or late production sets. Use original parts where possible, then stock new parts.
	New	Late			
C	Original	Early			New parts only may be used in early or late production sets. Stock new parts.
	New	Late			
D	Original	Early			Original parts may be used in early production sets only. New parts may be used in late production sets only. Stock both original and new parts.
	New	Late			
E	Other				
Part Number					
Model No.	Ref. No.	Original Part No.	New Part No.	Notes (* - **)	Part Name & Descriptions
RS-M260	G3(N)	QGCM0037 (Black)	QGCM0036 (Silver)	3-D	Bottom Cover
"	G5(D)	QYT0586K (Black)	QTY0586 (Silver)	"	Volume Knob-A Assembly
"	G6(D)	QTY0587K (Black)	QTY0587 (Silver)	"	Volume Knob-B Assembly
"	G7(D)	QG01692K (Black)	QG01692 (Silver)	"	Push Button (Power ON/OFF)
"	G8(D)	QG01694K (Black)	QG01694 (Silver)	"	Push Button (Monitor/Dolby NR/ Input Select)
"	G9(D)	QGT1515K (Black)	QGT1515 (Silver)	"	Counter Knob (Tape Select/ Output Level)
"	G40(N)	XWC3B	—————	6-D	Washer(3φ)
"	P4(D/B)	XZB40X60A02	XZB50X65A02	3-D	Poly Bag

File this Parts Change Notice with your copy of the Service Manual.

Original Service Manual is Model No. RS-M260(D/B) Order No. ARD8008083C.

(N) Order No. ARD8012131A01.

Technics
National / Panasonic

Matsushita Electric Trading Co., Ltd.

P.O. Box 288, Central Osaka Japan
Printed in Japan